

AKSAL

Alüminyum



Biz Kimiz?

Aksal Alüminyum, alüminyum profil sektöründe yılların tecrübesiyle müşterilerine kaliteli, dayanıklı ve estetik çözümler sunmaktadır. Alüminyum profil satışı konusunda uzman ekibimiz ve geniş ürün yelpazemiz ile inşaat, sanayi, mimari projeler gibi birçok farklı sektöre hizmet veriyoruz. Yüksek müşteri memnuniyeti odaklı anlayışımız, ileri teknoloji ürünlerimiz ve yenilikçi çözümlerimizle sektörde fark yaratıyoruz. Güçlü tedarik zincirimiz ve geniş stok kapasitemiz sayesinde müşterilerimize hızlı, güvenilir ve kaliteli hizmet sunmaktan gurur duyuyoruz.

Misyonumuz

Müşterilerimize kaliteli, yenilikçi ve dayanıklı alüminyum profil ürünleri sunarak, onların projelerini başarıyla tamamlamalarına katkıda bulunmak. Sürdürülebilirlik ve çevre dostu üretim süreçleriyle topluma ve çevreye duyarlı bir marka olmak. Müşteri memnuniyetini her zaman ön planda tutarak, sektördeki güçlü konumumuzu korumak ve büyümeye devam etmek.

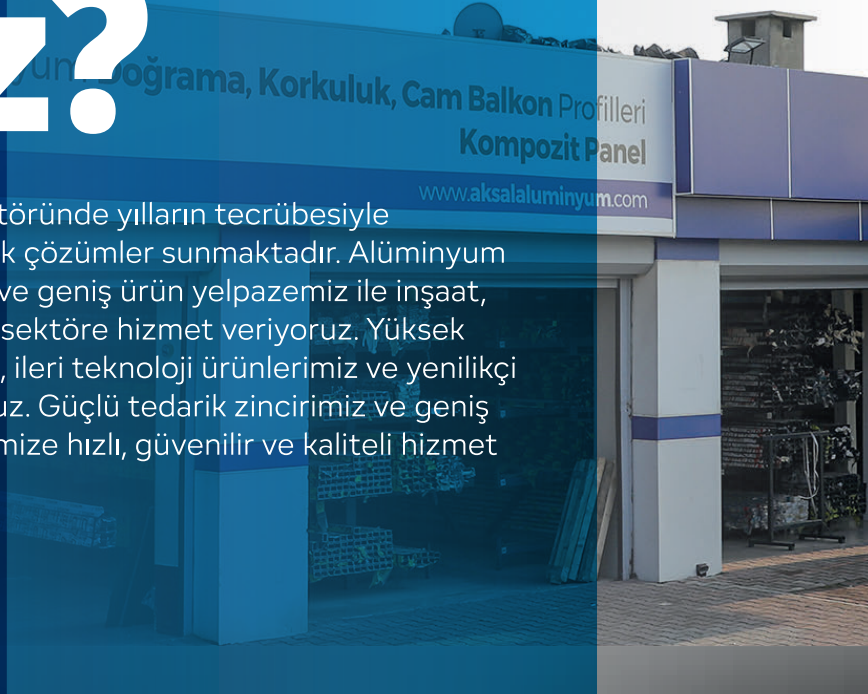



ALÜMİNYUM
PROFİL
AKSESUAR
KOMPOZİT PANEL

Vizyonumuz

Alüminyum profil sektöründe yeniliklerin öncüsü olarak, sürdürülebilir ve yüksek kaliteli ürünlerimizle global pazarda lider konuma ulaşmak. Teknolojik gelişmeleri yakından takip ederek, müşterilerimize her zaman en iyi çözümleri sunan ve sektörde güvenilen bir marka olmak.

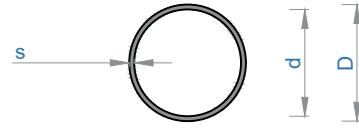
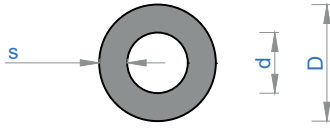

Sistem Kodu	D (mm)	d (mm)	s (mm)	Ağırlık (kg/mt)
88	16	13	1.5	0,185
64	18	14	2	0,272
77	16	9	3.5	0,372
83	20	8	6	0,715
25	20	6.5	6.75	0,761
78	22	10	6	0,817
65	25	13	6	0,971
102	29	14	7.5	1,373
81	30	14	8	1,498
79	32	20	6	1,328
80	32	14	9	1,762
84	32	9	11.5	2,007
74	35	23	6	1,481
70	35	14	10.5	2,190
27	35	10	12.5	2,394
72	35	9	13	2,435
73	40	26	7	1,967
82	40	14	13	2,988
98	45	22	11.5	3,780
66	48	14	17	4,487
85	55	40	7.5	3,033
71	55	16	19.5	5,894
5119	55	35	10	3,831
63	58	51	3.5	1,624
59	60	50	5	2,341
96	60	40	10	4,257
97	60	30	15	5,747
76	65	42	11.5	5,236
75	65	16	24.5	8,448
86	65	14	25.5	8,575
5199	70	60	5	2,766
99	70	40	15	7,024
101	70	14	28	10,012
370	91	77	7	5,006

Sistem Kodu	D (mm)	d (mm)	s (mm)	Ağırlık (kg/mt)
374	10	7.7	1.15	0,087
5123	13	10.6	1.3	0,122
221	16	13.8	1.1	0,140
388	16	13.4	1.3	0,163
318	16	12	2	0,238
218	19	16.6	1.2	0,182
89	19	15	2	0,289
217	22	19.6	1.2	0,213
322	24	18	3	0,536
10109	25	22.8	1.1	0,224
181	25	22.6	1.2	0,242
10116	29.2	25.6	1.8	0,420
321	30	27	1.5	0,364
13601	35	33	1	0,290
324	35	32	1.5	0,429
300	35	31.4	1.8	0,509
214	35	31	2	0,562
361	35	30	2.5	0,692
372	40	36	2	0,647
226	40	36.6	1.7	0,554
13602	42	35	3.5	1,147
13600	42	40	1	0,349
299	50	45.6	2.2	0,895
282	50	45	2.5	1,011
317	50	46	2	0,817
326	50	46.4	1.8	0,739
287	50	46.8	1.6	0,659
201	50	47	1.5	0,617
213	50	47.4	1.3	0,537
63	58	51	3.5	1,624
325	60	57	1.5	0,747
279	64	60.3	1.8	0,771
285	65	61.4	1.8	0,969
316	80	76	2	1,328
371	100	96	2	1,669
13750	153	149.5	2	2,581

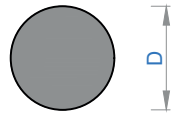

Sistem Kodu	D (mm)	Ağırlık (kg/mt)
62	14	0,416
13	19.3	0,790
9	20	0,848
16	22.5	1,074
60	25	1,325
61	28	1,663
5173	50	5,320
58	60	7,634
100	70	10,429
87	80	13,572

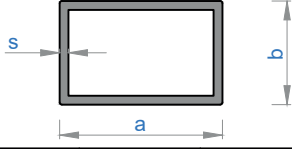

Sistem Kodu	a (mm)	b (mm)	s (mm)	Ağırlık (kg/mt)
224	13.5	13.5	1.05	0,141
5107	14	14	1.1	0,154
222	14	14	1.3	0,178
396	15	15	2	0,281
10108	20	20	1	0,206
5131	20	30	2	0,499
205	20	40	1.1	0,343
367	20	60	1.2	0,505
13583	20	80	1.3	0,684
13593	20	100	1.4	0,886
13592	20	120	1.5	1,109
13591	20	150	1.7	1,529
5133	20	180	1.8	1,916
13701	20	200	1.9	2,218
4811	21.5	36.2	2	0,582
262	25	17	1.2	0,256
390	25	40	1.4	0,470
13313	27.25	43.25	0.85	0,313
13400	28	44	1.5	0,559
5136	30	30	1.5	0,463
5134	30	60	3	1,366
13674	30	120	3	2,333
268	32	75	1.2	0,677
5143	30	100	3	2,016
191	40	40	1.2	0,503
5139	40	40	1.5	0,626
5132	40	40	2	0,824
13673	40	40	3	1,199
261	40	50	1.2	0,567
5137	40	50	1.5	0,707
363	40	60	1.2	0,632
13728	40	60	2	1,037
5138	40	60	1.5	0,789
260	40	80	1.4	0,886
13729	40	100	3	2,171
5125	44.6	44.6	1.8	0,829
404	44.75	44.75	2	0,923
173	47.25	47.25	3.25	1,544
13675	50	50	2	1,037
267	50	100	1.5	1,190
13676	50	100	3	2,333
10124	70	70	1.5	1,111
10123	70	70	2	1,472
5194	85	85	1.8	1,616
10125	100	100	1.9	2,018
310	100	100	2	2,115

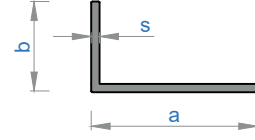

Sistem Kodu	a (mm)	b (mm)	s (mm)	Ağırlık (kg/mt)
264	10	30	1.1	0,115
356	10	40	1.1	0,145
251	20	20	1.1	0,115
249	20	40	1.1	0,175
248	20	60	1.1	0,234
250	20	80	1.1	0,293
247	20	100	1.1	0,353
13332	25	18	1.1	0,124
13401	25	20.1	0.9	0,107
10050	25	50	2	0,394
357	30	30	1.1	0,175
13740	30	60	5	1,151
355	40	40	2	0,421
387	40	40	3	0,624
13603	40	40	4	0,821
13061	40	60	3	0,786
13718	50	60	1.3	0,380
13560	50	70	5	1,523

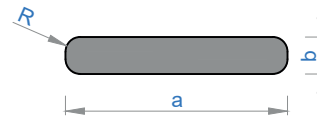

Sistem Kodu	a (mm)	b (mm)	R (mm)	Ağırlık (kg/mt)
10047	30.5	2.2	0.3	0,181
13732	30	10	0.5	0,810
11102	35	8	0.3	0,756
13707	40	12	0.3	1,295
5047	40	10	5	1,026
12	60	12	0.3	1,944
378	60	10	0.3	1,620
40	65	3.5	3.5	0,604
6	100	10	0.3	2,710
36	130	10	0.3	3,510
37	200	20	4	10,791

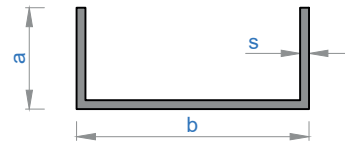

Sistem Kodu	a (mm)	b (mm)	s (mm)	Ağırlık (kg/mt)
5161	22,4	12,5	1.5	0,221
5160	22,4	14,8	1.5	0,230
10077	20	17	2	0,287
13741	25	25	3	0,561
13742	30	30	3	0,845
5094	40	40	1.9	0,599
5090	40	80	2	0,846
13743	50	50	3	1,170

<p>Sistem Kodu 371</p> <p>Ağırlık (kg/mt) 1,669</p>	<p>Sistem Kodu 316</p> <p>Ağırlık (kg/mt) 1,328</p>	<p>Sistem Kodu 285</p> <p>Ağırlık (kg/mt) 0,969</p>
<p>Sistem Kodu 279</p> <p>Ağırlık (kg/mt) 0,771</p>	<p>Sistem Kodu 325</p> <p>Ağırlık (kg/mt) 0,747</p>	<p>Sistem Kodu 63</p> <p>Ağırlık (kg/mt) 1,624</p>
<p>Sistem Kodu 213</p> <p>Ağırlık (kg/mt) 0,537</p>	<p>Sistem Kodu 201</p> <p>Ağırlık (kg/mt) 0,617</p>	<p>Sistem Kodu 287</p> <p>Ağırlık (kg/mt) 0,659</p>
<p>Sistem Kodu 326</p> <p>Ağırlık (kg/mt) 0,739</p>	<p>Sistem Kodu 317</p> <p>Ağırlık (kg/mt) 0,817</p>	<p>Sistem Kodu 299</p> <p>Ağırlık (kg/mt) 0,895</p>
<p>Sistem Kodu 282</p> <p>Ağırlık (kg/mt) 1,011</p>	<p>Sistem Kodu 13600</p> <p>Ağırlık (kg/mt) 0,349</p>	<p>Sistem Kodu 13602</p> <p>Ağırlık (kg/mt) 1,147</p>
<p>Sistem Kodu 226</p> <p>Ağırlık (kg/mt) 0,554</p>	<p>Sistem Kodu 372</p> <p>Ağırlık (kg/mt) 0,647</p>	<p>Sistem Kodu 13601</p> <p>Ağırlık (kg/mt) 0,290</p>
<p>Sistem Kodu 324</p> <p>Ağırlık (kg/mt) 0,429</p>	<p>Sistem Kodu 300</p> <p>Ağırlık (kg/mt) 0,509</p>	<p>Sistem Kodu 214</p> <p>Ağırlık (kg/mt) 0,562</p>

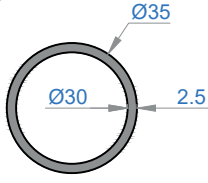
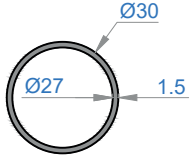
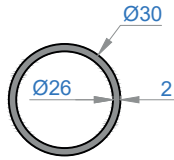
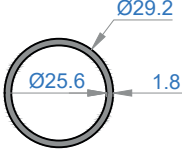
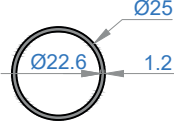
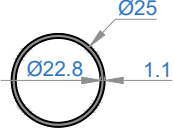
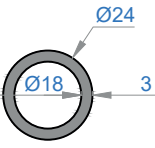
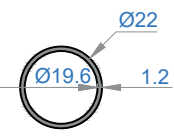
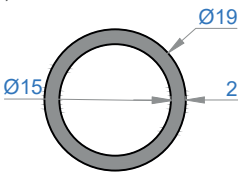
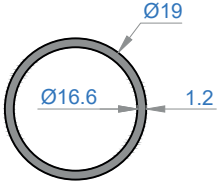
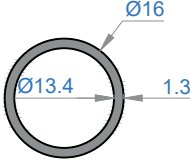
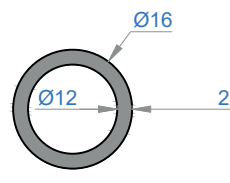
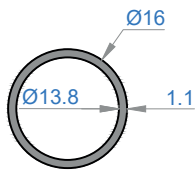
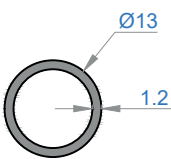
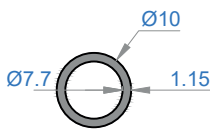
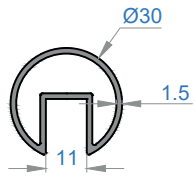
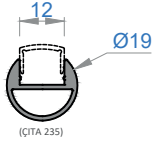
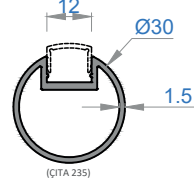
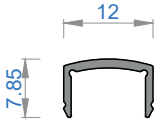
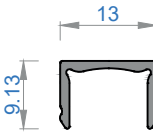
<p>Sistem Kodu 361 Ağırlık (kg/mt) 0,692</p> 	<p>Sistem Kodu 321 Ağırlık (kg/mt) 0,364</p> 	<p>Sistem Kodu 182* Ağırlık (kg/mt) 0,477</p> 
<p>Sistem Kodu 10116 Ağırlık (kg/mt) 0,420</p> 	<p>Sistem Kodu 181 Ağırlık (kg/mt) 0,242</p> 	<p>Sistem Kodu 10109 Ağırlık (kg/mt) 0,224</p> 
<p>Sistem Kodu 322 Ağırlık (kg/mt) 0,536</p> 	<p>Sistem Kodu 217 Ağırlık (kg/mt) 0,213</p> 	<p>Sistem Kodu 89 Ağırlık (kg/mt) 0,289</p> 
<p>Sistem Kodu 218 Ağırlık (kg/mt) 0,182</p> 	<p>Sistem Kodu 388 Ağırlık (kg/mt) 0,163</p> 	<p>Sistem Kodu 318 Ağırlık (kg/mt) 0,238</p> 
<p>Sistem Kodu 221 Ağırlık (kg/mt) 0,140</p> 	<p>Sistem Kodu 5123 Ağırlık (kg/mt) 0,122</p> 	<p>Sistem Kodu 374 Ağırlık (kg/mt) 0,087</p> 
<p>Sistem Kodu 320 Ağırlık (kg/mt) 0,483</p> 	<p>Sistem Kodu 223 Ağırlık (kg/mt) 0,240</p> 	<p>Sistem Kodu 10043 Ağırlık (kg/mt) 0,437</p> 
<p>Sistem Kodu 235 Ağırlık (kg/mt) 0,067</p> 	<p>Sistem Kodu 236 Ağırlık (kg/mt) 0,091</p> 	

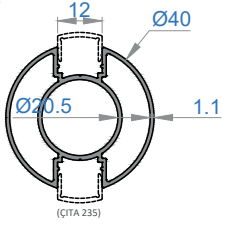
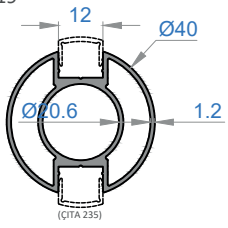
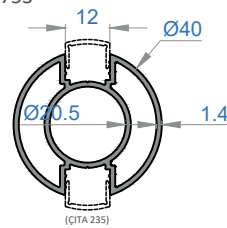
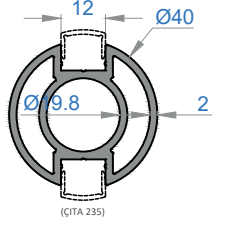
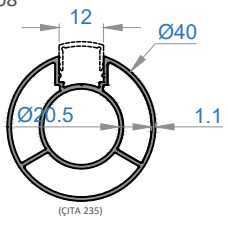
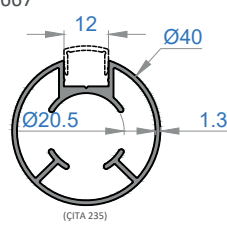
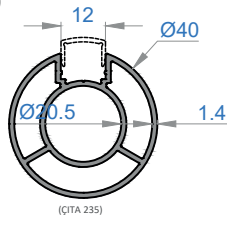
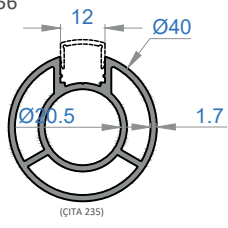
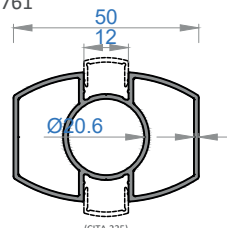
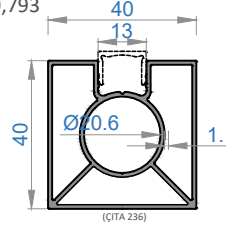
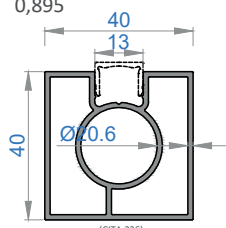
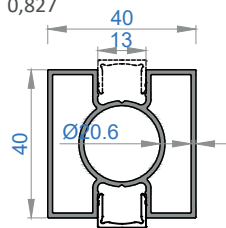
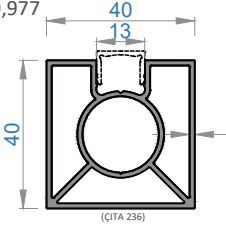
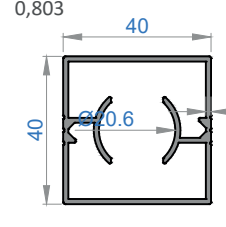
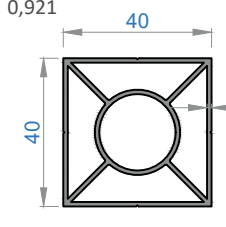
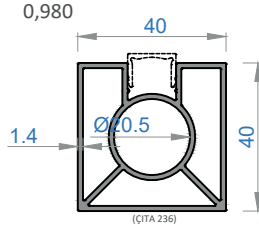
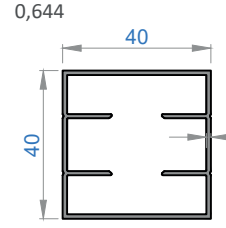
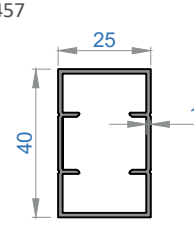
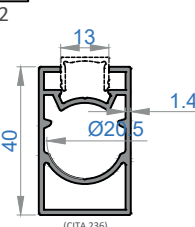
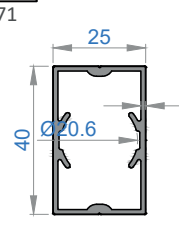
<p>Sistem Kodu 288</p> <p>Ağırlık (kg/mt) 0,601</p> 	<p>Sistem Kodu 278</p> <p>Ağırlık (kg/mt) 0,719</p> 	<p>Sistem Kodu 382</p> <p>Ağırlık (kg/mt) 0,753</p> 
<p>Sistem Kodu 283</p> <p>Ağırlık (kg/mt) 1,073</p> 	<p>Sistem Kodu 290</p> <p>Ağırlık (kg/mt) 0,608</p> 	<p>Sistem Kodu 368</p> <p>Ağırlık (kg/mt) 0,667</p> 
<p>Sistem Kodu 233</p> <p>Ağırlık (kg/mt) 0,790</p> 	<p>Sistem Kodu 13686</p> <p>Ağırlık (kg/mt) 0,956</p> 	<p>Sistem Kodu 323</p> <p>Ağırlık (kg/mt) 0,761</p> 
<p>Sistem Kodu 306</p> <p>Ağırlık (kg/mt) 0,793</p> 	<p>Sistem Kodu 234</p> <p>Ağırlık (kg/mt) 0,895</p> 	<p>Sistem Kodu 305</p> <p>Ağırlık (kg/mt) 0,827</p> 
<p>Sistem Kodu 381</p> <p>Ağırlık (kg/mt) 0,977</p> 	<p>Sistem Kodu 232</p> <p>Ağırlık (kg/mt) 0,803</p> 	<p>Sistem Kodu 5095</p> <p>Ağırlık (kg/mt) 0,921</p> 
<p>Sistem Kodu 206</p> <p>Ağırlık (kg/mt) 0,980</p> 	<p>Sistem Kodu 10075</p> <p>Ağırlık (kg/mt) 0,644</p> 	<p>Sistem Kodu 10074</p> <p>Ağırlık (kg/mt) 0,457</p> 
<p>Sistem Kodu 334</p> <p>Ağırlık (kg/mt) 0,662</p> 	<p>Sistem Kodu 231</p> <p>Ağırlık (kg/mt) 0,571</p> 	

<p>Sistem Kodu 204 Ağırlık (kg/mt) 0,738</p>	<p>Sistem Kodu 303 Ağırlık (kg/mt) 0,876</p>	<p>Sistem Kodu 212 Ağırlık (kg/mt) 0,768</p>
<p>Sistem Kodu 215 Ağırlık (kg/mt) 0,768</p>	<p>Sistem Kodu 216 Ağırlık (kg/mt) 1,000</p>	<p>Sistem Kodu 207 Ağırlık (kg/mt) 1,350</p>
<p>Sistem Kodu 219 Ağırlık (kg/mt) 0,722</p>	<p>Sistem Kodu 220 Ağırlık (kg/mt) 0,927</p>	<p>Sistem Kodu 225 Ağırlık (kg/mt) 1,030</p>
<p>Sistem Kodu 331 Ağırlık (kg/mt) 0,631</p>	<p>Sistem Kodu 332 Ağırlık (kg/mt) 0,782</p>	<p>Sistem Kodu 490 Ağırlık (kg/mt) 0,882</p>
<p>Sistem Kodu 202 Ağırlık (kg/mt) 0,667</p>	<p>Sistem Kodu 330 Ağırlık (kg/mt) 0,626</p>	<p>Sistem Kodu 612 Ağırlık (kg/mt) 1,248</p>
<p>Sistem Kodu 11063 Ağırlık (kg/mt) 0,838</p>	<p>Sistem Kodu 13346 Ağırlık (kg/mt) 0,692</p>	<p>Sistem Kodu 613 Ağırlık (kg/mt) 1,045</p>
<p>Sistem Kodu 121 Ağırlık (kg/mt) 0,719</p>	<p>Sistem Kodu 5098 Ağırlık (kg/mt) 0,920</p>	<p>Sistem Kodu 5077 Ağırlık (kg/mt) 1,154</p>

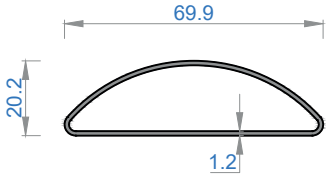
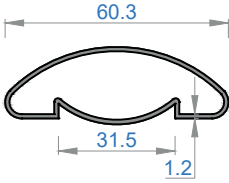
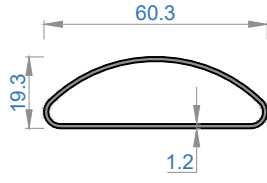
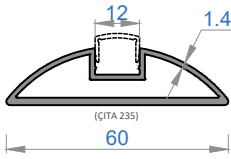
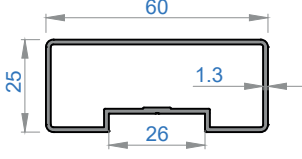
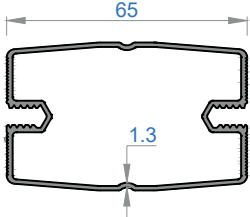
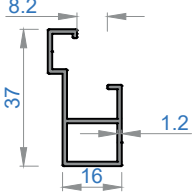
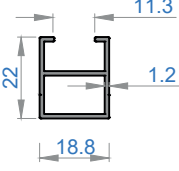
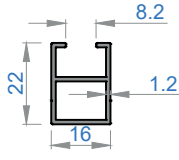
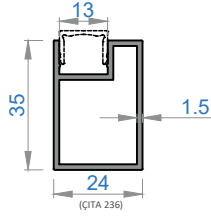
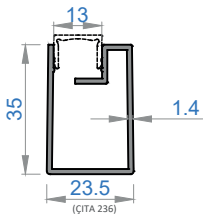
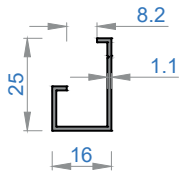
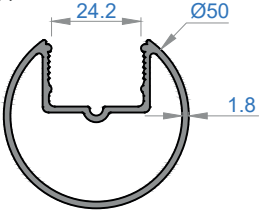
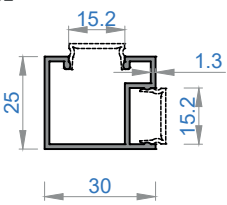
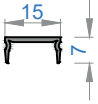
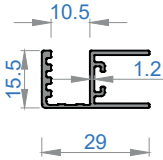
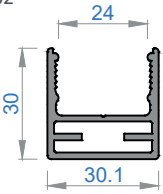
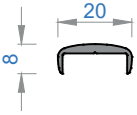
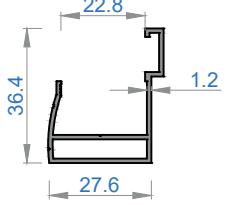
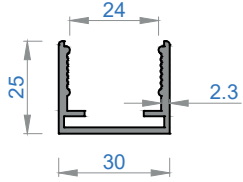
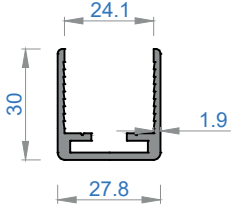
<p>Sistem Kodu 5106 Ağırlık (kg/mt) 0,491</p> 	<p>Sistem Kodu 301 Ağırlık (kg/mt) 0,457</p> 	<p>Sistem Kodu 125 Ağırlık (kg/mt) 0,414</p> 
<p>Sistem Kodu 308 Ağırlık (kg/mt) 0,623</p>  <p>(ÇİTA 235)</p>	<p>Sistem Kodu 383 Ağırlık (kg/mt) 0,614</p> 	<p>Sistem Kodu 13060 Ağırlık (kg/mt) 0,850</p> 
<p>Sistem Kodu 228 Ağırlık (kg/mt) 0,327</p> 	<p>Sistem Kodu 229 Ağırlık (kg/mt) 0,267</p> 	<p>Sistem Kodu 230 Ağırlık (kg/mt) 0,249</p> 
<p>Sistem Kodu 329 Ağırlık (kg/mt) 0,493</p>  <p>(ÇİTA 236)</p>	<p>Sistem Kodu 376 Ağırlık (kg/mt) 0,433</p>  <p>(ÇİTA 236)</p>	<p>Sistem Kodu 360 Ağırlık (kg/mt) 0,168</p> 
<p>Sistem Kodu 11062 Ağırlık (kg/mt) 0,904</p> 	<p>Sistem Kodu 13347 Ağırlık (kg/mt) 0,362</p> 	<p>Sistem Kodu 13348 Ağırlık (kg/mt) 0,079</p> 
<p>Sistem Kodu 10040 Ağırlık (kg/mt) 0,275</p> 	<p>Sistem Kodu 11064 Ağırlık (kg/mt) 0,662</p> 	<p>Sistem Kodu 11065 Ağırlık (kg/mt) 0,136</p> 
<p>Sistem Kodu 491 Ağırlık (kg/mt) 0,384</p> 	<p>Sistem Kodu 5171 Ağırlık (kg/mt) 0,458</p> 	<p>Sistem Kodu 5170 Ağırlık (kg/mt) 0,510</p> 

<p>Sistem Kodu 359 Ağırlık (kg/mt) 2,174</p>	<p>Sistem Kodu 208 Ağırlık (kg/mt) 1,439</p>	<p>Sistem Kodu 11066 Ağırlık (kg/mt) 0,976</p>	
<p>Sistem Kodu 610 Ağırlık (kg/mt) 1,958</p>	<p>Sistem Kodu 336 Ağırlık (kg/mt) 0,772</p>	<p>Sistem Kodu 375 Ağırlık (kg/mt) 0,573</p>	
<p>Sistem Kodu 615 Ağırlık (kg/mt) 0,218</p>	<p>Sistem Kodu 614 Ağırlık (kg/mt) 0,306</p>	<p>Sistem Kodu 600 Ağırlık (kg/mt) 3,391</p>	
<p>Sistem Kodu 601 Ağırlık (kg/mt) 2,919</p>	<p>Sistem Kodu 602 Ağırlık (kg/mt) 4,105</p>	<p>Sistem Kodu 281 Ağırlık (kg/mt) 0,698</p>	<p>Sistem Kodu 280 Ağırlık (kg/mt) 0,618</p>
<p>Sistem Kodu 5190 Ağırlık (kg/mt) 0,217</p>	<p>Sistem Kodu 13754 Ağırlık (kg/mt) 5,325</p>	<p>Sistem Kodu 13755 Ağırlık (kg/mt) 0,638</p>	
<p>Sistem Kodu 611 Ağırlık (kg/mt) 1,583</p>	<p>Sistem Kodu 5075 Ağırlık (kg/mt) 5,797</p>	<p>Sistem Kodu 11928 Ağırlık (kg/mt) 6,639</p>	
<p>Sistem Kodu 5145 Ağırlık (kg/mt) 0,911</p>	<p>Sistem Kodu 5146 Ağırlık (kg/mt) 0,631</p>	<p>Sistem Kodu 295 Ağırlık (kg/mt) 0,117</p>	

<p>Sistem Kodu 13250 Ağırlık (kg/mt) 3,831</p>	<p>Sistem Kodu 309 Ağırlık (kg/mt) 2,868</p>	<p>Sistem Kodu 126 Ağırlık (kg/mt) 2,630</p>
<p>Sistem Kodu 5096 Ağırlık (kg/mt) 3,005</p>	<p>Sistem Kodu 310 Ağırlık (kg/mt) 2,125</p>	<p>Sistem Kodu 5194 Ağırlık (kg/mt) 1,616</p>
<p>Sistem Kodu 5097 Ağırlık (kg/mt) 2,176</p>	<p>Sistem Kodu 403 Ağırlık (kg/mt) 1,605</p>	<p>Sistem Kodu 315 Ağırlık (kg/mt) 2,045</p>
<p>Sistem Kodu 13616 Ağırlık (kg/mt) 1,879</p>	<p>Sistem Kodu 5172 Ağırlık (kg/mt) 1,710</p>	<p>Sistem Kodu 5144 Ağırlık (kg/mt) 2,606</p>
<p>Sistem Kodu 13251 Ağırlık (kg/mt) 0,326</p>	<p>Sistem Kodu 13573 Ağırlık (kg/mt) 11,034</p>	<p>Sistem Kodu 13574 Ağırlık (kg/mt) 5,485</p>
<p>Sistem Kodu 296 Ağırlık (kg/mt) 0,651</p>	<p>Sistem Kodu 297 Ağırlık (kg/mt) 0,645</p>	<p>Sistem Kodu 5126 Ağırlık (kg/mt) 0,635</p>
<p>Sistem Kodu 10041 Ağırlık (kg/mt) 0,648</p>	<p>Sistem Kodu 10042 Ağırlık (kg/mt) 0,629</p>	<p>Sistem Kodu 5162 Ağırlık (kg/mt) 0,211</p>

<p>Sistem Kodu 501</p> <p>Ağırlık (kg/mt) 0,853</p> <p>Statik J_x (cm⁴) 15,72</p> <p>Statik J_y (cm⁴) 10,37</p>	<p>Sistem Kodu 252</p> <p>Ağırlık (kg/mt) 1,005</p> <p>Statik J_x (cm⁴) 18,45</p> <p>Statik J_y (cm⁴) 11,74</p>	<p>Sistem Kodu 503</p> <p>Ağırlık (kg/mt) 1,180</p> <p>Statik J_x (cm⁴) 21,51</p> <p>Statik J_y (cm⁴) 13,27</p>
<p>Sistem Kodu 502</p> <p>Ağırlık (kg/mt) 0,892</p> <p>Statik J_x (cm⁴) 19,14</p> <p>Statik J_y (cm⁴) 11,86</p>	<p>Sistem Kodu 254</p> <p>Ağırlık (kg/mt) 1,044</p> <p>Statik J_x (cm⁴) 21,67</p> <p>Statik J_y (cm⁴) 13,49</p>	<p>Sistem Kodu 504</p> <p>Ağırlık (kg/mt) 1,219</p> <p>Statik J_x (cm⁴) 24,57</p> <p>Statik J_y (cm⁴) 15,24</p>
<p>Sistem Kodu 506</p> <p>Ağırlık (kg/mt) 0,803</p> <p>Statik J_x (cm⁴) 11,63</p> <p>Statik J_y (cm⁴) 0,95</p>	<p>Sistem Kodu 241</p> <p>Ağırlık (kg/mt) 1,410</p> <p>Statik J_x (cm⁴) 32,32</p> <p>Statik J_y (cm⁴) 18,58</p>	<p>Sistem Kodu 253</p> <p>Ağırlık (kg/mt) 0,593</p>
<p>Sistem Kodu 240</p> <p>Ağırlık (kg/mt) 0,510</p> <p>Statik J_x (cm⁴) 0,20</p> <p>Statik J_y (cm⁴) 8,30</p>	<p>Sistem Kodu 239</p> <p>Ağırlık (kg/mt) 0,347</p> <p>Statik J_x (cm⁴) 0,13</p> <p>Statik J_y (cm⁴) 4,52</p>	<p>Sistem Kodu 149</p> <p>Ağırlık (kg/mt) 0,526</p>
<p>Sistem Kodu 509</p> <p>Ağırlık (kg/mt) 0,202</p>	<p>Sistem Kodu 238</p> <p>Ağırlık (kg/mt) 0,394</p>	<p>Sistem Kodu 246</p> <p>Ağırlık (kg/mt) 0,226</p>
<p>Sistem Kodu 243</p> <p>Ağırlık (kg/mt) 0,235</p>	<p>Sistem Kodu 511</p> <p>Ağırlık (kg/mt) 0,231</p>	<p>Sistem Kodu 500</p> <p>Ağırlık (kg/mt) 0,250</p>
<p>Sistem Kodu 507</p> <p>Ağırlık (kg/mt) 0,229</p>	<p>Sistem Kodu 270</p> <p>Ağırlık (kg/mt) 1,083</p>	<p>Sistem Kodu 245</p> <p>Ağırlık (kg/mt) 1,236</p>

<p>Sistem Kodu 257</p> <p>Ağırlık (kg/mt) 0,499</p> <p>Statik Jx (cm⁴) 5,69</p> <p>Statik Jy (cm⁴) 1,86</p>	<p>Sistem Kodu 259</p> <p>Ağırlık (kg/mt) 0,601</p> <p>Statik Jx (cm⁴) 6,50</p> <p>Statik Jy (cm⁴) 4,23</p>	<p>Sistem Kodu 258</p> <p>Ağırlık (kg/mt) 0,602</p> <p>Statik Jx (cm⁴) 8,66</p> <p>Statik Jy (cm⁴) 2,67</p>
<p>Sistem Kodu 5178</p> <p>Ağırlık (kg/mt) 0,577</p>	<p>Sistem Kodu 5179</p> <p>Ağırlık (kg/mt) 0,669</p>	<p>Sistem Kodu 5180</p> <p>Ağırlık (kg/mt) 0,669</p>
<p>Sistem Kodu 255</p> <p>Ağırlık (kg/mt) 0,651</p> <p>Statik Jx (cm⁴) 9,25</p> <p>Statik Jy (cm⁴) 6,06</p>	<p>Sistem Kodu 256</p> <p>Ağırlık (kg/mt) 0,752</p> <p>Statik Jx (cm⁴) 9,01</p> <p>Statik Jy (cm⁴) 11,06</p>	<p>Sistem Kodu 263</p> <p>Ağırlık (kg/mt) 0,751</p> <p>Statik Jx (cm⁴) 6,55</p> <p>Statik Jy (cm⁴) 14,00</p>
<p>Sistem Kodu 392</p> <p>Ağırlık (kg/mt) 1,037</p> <p>Statik Jx (cm⁴) 14,12</p> <p>Statik Jy (cm⁴) 9,25</p>	<p>Sistem Kodu 393</p> <p>Ağırlık (kg/mt) 1,165</p> <p>Statik Jx (cm⁴) 13,50</p> <p>Statik Jy (cm⁴) 15,96</p>	<p>Sistem Kodu 391</p> <p>Ağırlık (kg/mt) 1,166</p> <p>Statik Jx (cm⁴) 9,60</p> <p>Statik Jy (cm⁴) 20,63</p>
<p>Sistem Kodu 353</p> <p>Ağırlık (kg/mt) 1,116</p> <p>Statik Jx (cm⁴) 14,95</p> <p>Statik Jy (cm⁴) 41,23</p>	<p>Sistem Kodu 237</p> <p>Ağırlık (kg/mt) 1,314</p> <p>Statik Jx (cm⁴) 51,71</p> <p>Statik Jy (cm⁴) 15,29</p>	<p>Sistem Kodu 11082</p> <p>Ağırlık (kg/mt) 0,958</p> <p>Statik Jx (cm⁴) 12,20</p> <p>Statik Jy (cm⁴) 26,38</p>
<p>Sistem Kodu 11083</p> <p>Ağırlık (kg/mt) 1,114</p> <p>Statik Jx (cm⁴) 13,80</p> <p>Statik Jy (cm⁴) 42,67</p>	<p>Sistem Kodu 348</p> <p>Ağırlık (kg/mt) 0,816</p> <p>Statik Jx (cm⁴) 17,95</p> <p>Statik Jy (cm⁴) 8,70</p>	<p>Sistem Kodu 265</p> <p>Ağırlık (kg/mt) 0,753</p> <p>Statik Jx (cm⁴) 17,43</p> <p>Statik Jy (cm⁴) 4,76</p>
<p>Sistem Kodu 253</p> <p>Ağırlık (kg/mt) 0,593</p>	<p>Sistem Kodu 394</p> <p>Ağırlık (kg/mt) 0,355</p>	<p>Sistem Kodu 395</p> <p>Ağırlık (kg/mt) 0,291</p>

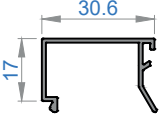
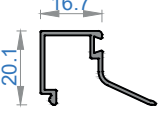
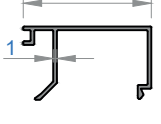
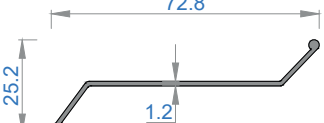
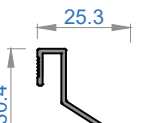
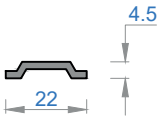
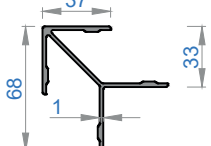
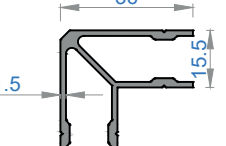
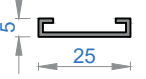
<p>Sistem Kodu 242 Ağırlık (kg/mt) 0,235</p> 	<p>Sistem Kodu 244 Ağırlık (kg/mt) 0,220</p> 	<p>Sistem Kodu 5181 Ağırlık (kg/mt) 0,228</p> 
<p>Sistem Kodu 369 Ağırlık (kg/mt) 0,195</p> 	<p>Sistem Kodu 351 Ağırlık (kg/mt) 0,190</p> 	<p>Sistem Kodu 328 Ağırlık (kg/mt) 0,135</p> 
<p>Sistem Kodu 270 Ağırlık (kg/mt) 1,083</p> 	<p>Sistem Kodu 275 Ağırlık (kg/mt) 0,600</p> 	<p>Sistem Kodu 327 Ağırlık (kg/mt) 0,124</p> 

<p>Sistem Kodu 4000*</p> <p>Ağırlık (kg/mt) 1,053</p> <p>Jx (cm⁴) 14,83</p> <p>Jy (cm⁴) 3,52</p>	<p>Sistem Kodu 4001</p> <p>Ağırlık (kg/mt) 1,222</p> <p>Jx (cm⁴) 19,20</p> <p>Jy (cm⁴) 10,10</p>	<p>Sistem Kodu 4002*</p> <p>Ağırlık (kg/mt) 1,428</p> <p>Jx (cm⁴) 22,59</p> <p>Jy (cm⁴) 30,53</p>
<p>Sistem Kodu 4003*</p> <p>Ağırlık (kg/mt) 1,200</p> <p>Jx (cm⁴) 16,02</p> <p>Jy (cm⁴) 6,58</p>	<p>Sistem Kodu 4004</p> <p>Ağırlık (kg/mt) 1,375</p> <p>Jx (cm⁴) 20,29</p> <p>Jy (cm⁴) 15,66</p>	<p>Sistem Kodu 4005*</p> <p>Ağırlık (kg/mt) 1,579</p> <p>Jx (cm⁴) 26,00</p> <p>Jy (cm⁴) 37,07</p>
<p>Sistem Kodu 4006*</p> <p>Ağırlık (kg/mt) 1,165</p> <p>Jx (cm⁴) 21,68</p> <p>Jy (cm⁴) 3,90</p>	<p>Sistem Kodu 4007*</p> <p>Ağırlık (kg/mt) 1,337</p> <p>Jx (cm⁴) 28,98</p> <p>Jy (cm⁴) 10,20</p>	<p>Sistem Kodu 4008</p> <p>Ağırlık (kg/mt) 1,565</p> <p>Jx (cm⁴) 24,14</p> <p>Jy (cm⁴) 43,64</p>
<p>Sistem Kodu 4009</p> <p>Ağırlık (kg/mt) 1,538</p> <p>Jx (cm⁴) 34,08</p> <p>Jy (cm⁴) 14,55</p>	<p>Sistem Kodu 4010*</p> <p>Ağırlık (kg/mt) 1,703</p> <p>Jx (cm⁴) 24,90</p> <p>Jy (cm⁴) 44,80</p>	<p>Sistem Kodu 4016*</p> <p>Ağırlık (kg/mt) 1,706</p> <p>Jx (cm⁴) 32,15</p> <p>Jy (cm⁴) 59,61</p>
<p>Sistem Kodu 4011*</p> <p>Ağırlık (kg/mt) 1,565</p> <p>Jx (cm⁴) 31,30</p> <p>Jy (cm⁴) 35,52</p>	<p>Sistem Kodu 4114</p> <p>Ağırlık (kg/mt) 1,398</p> <p>Jx (cm⁴) 68,08</p> <p>Jy (cm⁴) 26,15</p>	<p>Sistem Kodu 4014</p> <p>Ağırlık (kg/mt) 1,812</p> <p>Jx (cm⁴) 20,21</p> <p>Jy (cm⁴) 45,50</p>
<p>Sistem Kodu 4100*</p> <p>Ağırlık (kg/mt) 0,824</p> <p>Jx (cm⁴) 12,00</p> <p>Jy (cm⁴) 3,03</p>	<p>Sistem Kodu 4101</p> <p>Ağırlık (kg/mt) 0,949</p> <p>Jx (cm⁴) 15,76</p> <p>Jy (cm⁴) 8,25</p>	<p>Sistem Kodu 4102</p> <p>Ağırlık (kg/mt) 1,090</p> <p>Jx (cm⁴) 16,92</p> <p>Jy (cm⁴) 25,14</p>
<p>Sistem Kodu 4115</p> <p>Ağırlık (kg/mt) 1,055</p> <p>Jx (cm⁴) 22,12</p> <p>Jy (cm⁴) 10,36</p>	<p>Sistem Kodu 4103*</p> <p>Ağırlık (kg/mt) 0,996</p> <p>Jx (cm⁴) 13,55</p> <p>Jy (cm⁴) 6,30</p>	<p>Sistem Kodu 4104</p> <p>Ağırlık (kg/mt) 1,125</p> <p>Jx (cm⁴) 16,68</p> <p>Jy (cm⁴) 14,37</p>

<p>Sistem Kodu 4105</p> <p>Ağırlık (kg/mt) 1,261</p> <p>Jx (cm⁴) 20,76</p> <p>Jy (cm⁴) 32,56</p>	<p>Sistem Kodu 4106*</p> <p>Ağırlık (kg/mt) 0,959</p> <p>Jx (cm⁴) 19,61</p> <p>Jy (cm⁴) 3,43</p>	<p>Sistem Kodu 4107</p> <p>Ağırlık (kg/mt) 1,065</p> <p>Jx (cm⁴) 25,15</p> <p>Jy (cm⁴) 8,33</p>
<p>Sistem Kodu 4108</p> <p>Ağırlık (kg/mt) 1,225</p> <p>Jx (cm⁴) 18,40</p> <p>Jy (cm⁴) 38,05</p>	<p>Sistem Kodu 4109</p> <p>Ağırlık (kg/mt) 1,214</p> <p>Jx (cm⁴) 29,20</p> <p>Jy (cm⁴) 11,82</p>	<p>Sistem Kodu 4110</p> <p>Ağırlık (kg/mt) 1,318</p> <p>Jx (cm⁴) 18,90</p> <p>Jy (cm⁴) 38,55</p>
<p>Sistem Kodu 4111*</p> <p>Ağırlık (kg/mt) 1,222</p> <p>Jx (cm⁴) 25,01</p> <p>Jy (cm⁴) 30,00</p>	<p>Sistem Kodu 4116</p> <p>Ağırlık (kg/mt) 1,323</p> <p>Jx (cm⁴) 24,13</p> <p>Jy (cm⁴) 51,46</p>	<p>Sistem Kodu 4193</p> <p>Ağırlık (kg/mt) 1,094</p> <p>Jx (cm⁴) 18,73</p> <p>Jy (cm⁴) 7,28</p>
<p>Sistem Kodu 4163*</p> <p>Ağırlık (kg/mt) 0,910</p> <p>Jx (cm⁴) 12,09</p> <p>Jy (cm⁴) 4,36</p>	<p>Sistem Kodu 4191*</p> <p>Ağırlık (kg/mt) 0,957</p> <p>Jx (cm⁴) 17,50</p> <p>Jy (cm⁴) 10,10</p>	<p>Sistem Kodu 4192*</p> <p>Ağırlık (kg/mt) 0,737</p> <p>Jx (cm⁴) 3,70</p> <p>Jy (cm⁴) 7,91</p>
<p>Sistem Kodu 4186*</p> <p>Ağırlık (kg/mt) 0,319</p>	<p>Sistem Kodu 4187*</p> <p>Ağırlık (kg/mt) 0,615</p>	<p>Sistem Kodu 4184</p> <p>Ağırlık (kg/mt) 0,283</p>
<p>Sistem Kodu 4183*</p> <p>Ağırlık (kg/mt) 0,206</p>	<p>Sistem Kodu 4185*</p> <p>Ağırlık (kg/mt) 0,270</p>	<p>Sistem Kodu 4190*</p> <p>Ağırlık (kg/mt) 0,228</p>
<p>Sistem Kodu 9009</p> <p>Ağırlık (kg/mt) 0,123</p>	<p>Sistem Kodu 4129</p> <p>Ağırlık (kg/mt) 0,199</p>	

<p>Sistem Kodu 4302-4303</p> <p>Ağırlık (kg/mt) 1,338</p> <p>Statik Jx (cm⁴) 17,05</p> <p>Statik Jy (cm⁴) 8,91</p>	<p>Sistem Kodu 4700-4701</p> <p>Ağırlık (kg/mt) 1,498</p> <p>Statik Jx (cm⁴) 19,80</p> <p>Statik Jy (cm⁴) 10,85</p>	<p>Sistem Kodu 4202-4203</p> <p>Ağırlık (kg/mt) 1,581</p> <p>Statik Jx (cm⁴) 20,31</p> <p>Statik Jy (cm⁴) 9,98</p>
<p>Sistem Kodu 4308-4309</p> <p>Ağırlık (kg/mt) 1,508</p> <p>Statik Jx (cm⁴) 18,01</p> <p>Statik Jy (cm⁴) 14,75</p>	<p>Sistem Kodu 4702-4703</p> <p>Ağırlık (kg/mt) 1,669</p> <p>Statik Jx (cm⁴) 20,65</p> <p>Statik Jy (cm⁴) 16,53</p>	<p>Sistem Kodu 4208-4209</p> <p>Ağırlık (kg/mt) 1,750</p> <p>Statik Jx (cm⁴) 21,51</p> <p>Statik Jy (cm⁴) 15,67</p>
<p>Sistem Kodu 4314-4315</p> <p>Ağırlık (kg/mt) 1,447</p> <p>Statik Jx (cm⁴) 26,04</p> <p>Statik Jy (cm⁴) 8,61</p>	<p>Sistem Kodu 4214-4215</p> <p>Ağırlık (kg/mt) 1,717</p> <p>Statik Jx (cm⁴) 29,98</p> <p>Statik Jy (cm⁴) 10,18</p>	<p>Sistem Kodu 4222-4223</p> <p>Ağırlık (kg/mt) 2,214</p> <p>Statik Jx (cm⁴) 33,91</p> <p>Statik Jy (cm⁴) 36,58</p>
<p>Sistem Kodu 4318-4319</p> <p>Ağırlık (kg/mt) 1,623</p> <p>Statik Jx (cm⁴) 30,45</p> <p>Statik Jy (cm⁴) 12,10</p>	<p>Sistem Kodu 4706-4707</p> <p>Ağırlık (kg/mt) 1,846</p> <p>Statik Jx (cm⁴) 34,71</p> <p>Statik Jy (cm⁴) 16,44</p>	<p>Sistem Kodu 4218-4219</p> <p>Ağırlık (kg/mt) 1,953</p> <p>Statik Jx (cm⁴) 35,27</p> <p>Statik Jy (cm⁴) 14,75</p>
<p>Sistem Kodu 4316-4317</p> <p>Ağırlık (kg/mt) 1,777</p> <p>Statik Jx (cm⁴) 20,22</p> <p>Statik Jy (cm⁴) 40,05</p>	<p>Sistem Kodu 4704-4705</p> <p>Ağırlık (kg/mt) 2,037</p> <p>Statik Jx (cm⁴) 21,10</p> <p>Statik Jy (cm⁴) 47,27</p>	<p>Sistem Kodu 4216-4217</p> <p>Ağırlık (kg/mt) 2,173</p> <p>Statik Jx (cm⁴) 25,84</p> <p>Statik Jy (cm⁴) 45,54</p>
<p>Sistem Kodu 4220-4221*</p> <p>Ağırlık (kg/mt) 2,257</p> <p>Statik Jx (cm⁴) 46,60</p> <p>Statik Jy (cm⁴) 25,85</p>	<p>Sistem Kodu 5182-5183</p> <p>Ağırlık (kg/mt) 2,121</p> <p>Statik Jx (cm⁴) 28,84</p> <p>Statik Jy (cm⁴) 90,25</p>	<p>Sistem Kodu 4228-4229</p> <p>Ağırlık (kg/mt) 2,728</p> <p>Statik Jx (cm⁴) 93,87</p> <p>Statik Jy (cm⁴) 36,99</p>
<p>Sistem Kodu 4300-4301</p> <p>Ağırlık (kg/mt) 1,084</p> <p>Statik Jx (cm⁴) 13,05</p> <p>Statik Jy (cm⁴) 3,15</p>	<p>Sistem Kodu 4306-4307</p> <p>Ağırlık (kg/mt) 1,229</p> <p>Statik Jx (cm⁴) 14,40</p> <p>Statik Jy (cm⁴) 6,25</p>	<p>Sistem Kodu 4312-4313</p> <p>Ağırlık (kg/mt) 1,201</p> <p>Statik Jx (cm⁴) 20,00</p> <p>Statik Jy (cm⁴) 3,36</p>

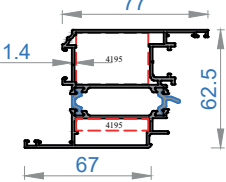
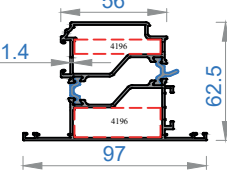
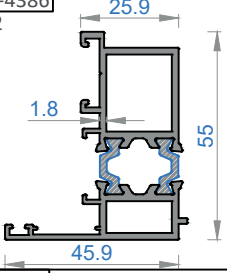
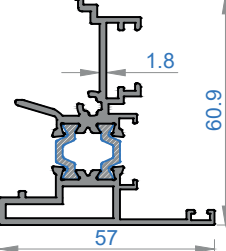
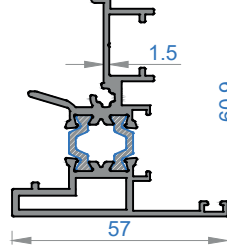
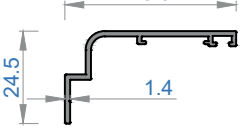
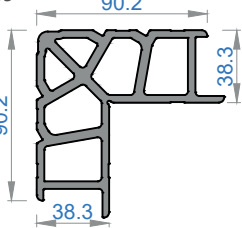
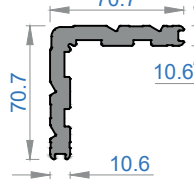
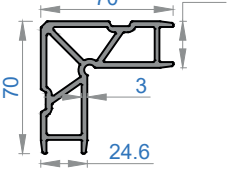
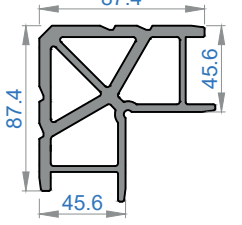
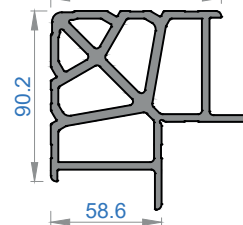
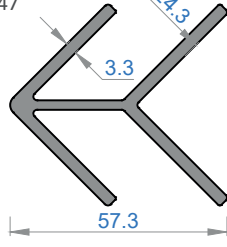
<p>Sistem Kodu 4320-4321</p> <p>Ağırlık (kg/mt) 1,841</p> <p>Statik / Statik / Statik</p> <p>Jx (cm⁴) 20,10</p> <p>Jy (cm⁴) 40,82</p> 	<p>Sistem Kodu 4322-4323</p> <p>Ağırlık (kg/mt) 1,800</p> <p>Statik / Statik / Statik</p> <p>Jx (cm⁴) 27,29</p> <p>Jy (cm⁴) 31,71</p> 	<p>Sistem Kodu 4385-4386</p> <p>Ağırlık (kg/mt) 1,202</p> <p>Statik / Statik / Statik</p> <p>Jx (cm⁴) 12,75</p> <p>Jy (cm⁴) 4,48</p> 
<p>Sistem Kodu 4380-4381</p> <p>Ağırlık (kg/mt) 1,311</p> <p>Statik / Statik / Statik</p> <p>Jx (cm⁴) 14,08</p> <p>Jy (cm⁴) 5,81</p> 	<p>Sistem Kodu 4387-4381</p> <p>Ağırlık (kg/mt) 1,297</p> <p>Statik / Statik / Statik</p> <p>Jx (cm⁴) 13,60</p> <p>Jy (cm⁴) 5,76</p> 	<p>Sistem Kodu 4184</p> <p>Ağırlık (kg/mt) 0,283</p> 
<p>Sistem Kodu 4195</p> <p>Ağırlık (kg/mt) 5,859</p> 	<p>Sistem Kodu 4499</p> <p>Ağırlık (kg/mt) 3,074</p> 	<p>Sistem Kodu 4194</p> <p>Ağırlık (kg/mt) 2,680</p> 
<p>Sistem Kodu 4196</p> <p>Ağırlık (kg/mt) 5,962</p> 	<p>Sistem Kodu 4023</p> <p>Ağırlık (kg/mt) 6,750</p> 	<p>Sistem Kodu 373</p> <p>Ağırlık (kg/mt) 1,447</p> 

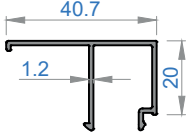
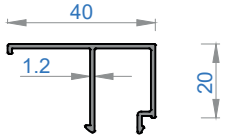
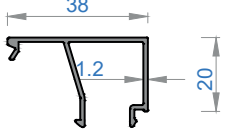
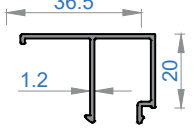
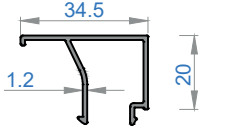
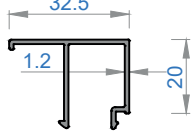
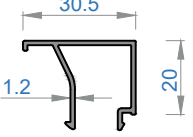
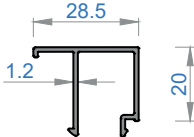
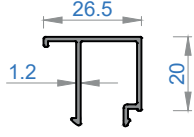
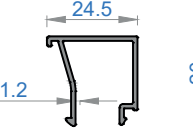
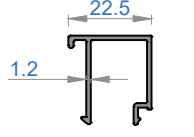
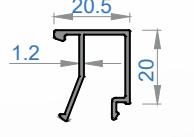
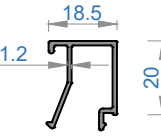
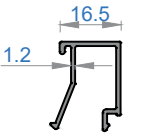
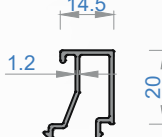
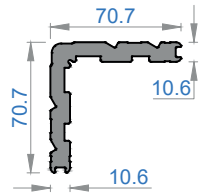
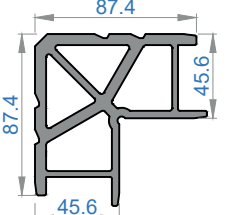
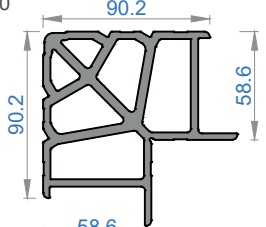
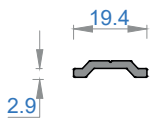
<p>Sistem Kodu 4189 Ağırlık (kg/mt) 0,305</p> 	<p>Sistem Kodu 4153 Ağırlık (kg/mt) 0,302</p> 	<p>Sistem Kodu 4160 Ağırlık (kg/mt) 0,315</p> 
<p>Sistem Kodu 4118* Ağırlık (kg/mt) 0,290</p> 	<p>Sistem Kodu 4152 Ağırlık (kg/mt) 0,287</p> 	<p>Sistem Kodu 4119* Ağırlık (kg/mt) 0,277</p> 
<p>Sistem Kodu 4120 Ağırlık (kg/mt) 0,274</p> 	<p>Sistem Kodu 4121* Ağırlık (kg/mt) 0,264</p> 	<p>Sistem Kodu 4122* Ağırlık (kg/mt) 0,258</p> 
<p>Sistem Kodu 4151 Ağırlık (kg/mt) 0,254</p> 	<p>Sistem Kodu 4123* Ağırlık (kg/mt) 0,248</p> 	<p>Sistem Kodu 4150 Ağırlık (kg/mt) 0,249</p> 
<p>Sistem Kodu 4124* Ağırlık (kg/mt) 0,230</p> 	<p>Sistem Kodu 4125* Ağırlık (kg/mt) 0,223</p> 	<p>Sistem Kodu 4126* Ağırlık (kg/mt) 0,228</p> 
<p>Sistem Kodu 4195 Ağırlık (kg/mt) 5,859</p> 	<p>Sistem Kodu 4499 Ağırlık (kg/mt) 3,074</p> 	<p>Sistem Kodu 4194 Ağırlık (kg/mt) 2,680</p> 
<p>Sistem Kodu 4196 Ağırlık (kg/mt) 5,962</p> 	<p>Sistem Kodu 4023 Ağırlık (kg/mt) 6,750</p> 	<p>Sistem Kodu 9009 Ağırlık (kg/mt) 0,123</p> 

AKSAL

Alüminyum

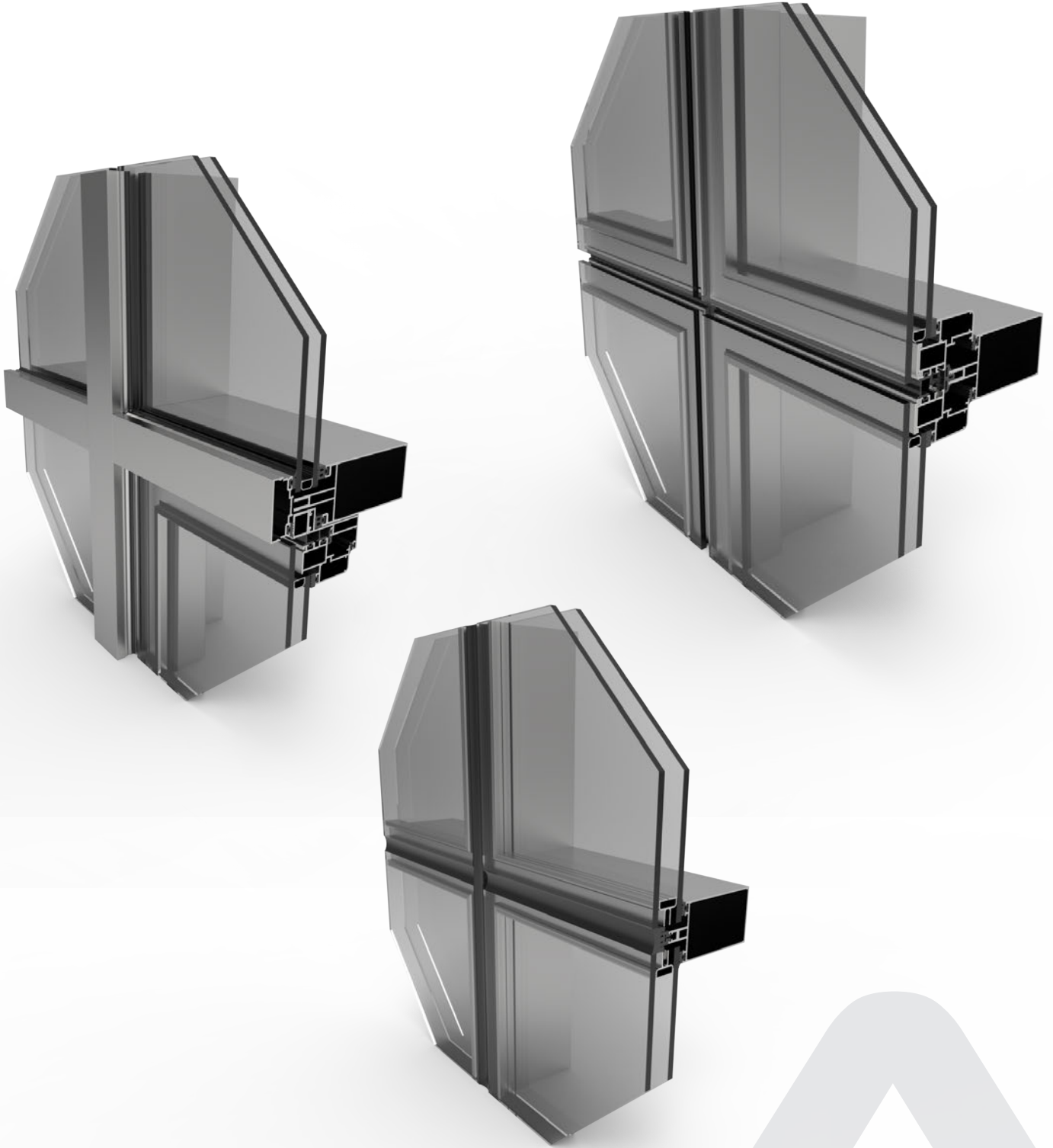

<p>Sistem Kodu 5000*</p> <p>Ağırlık (kg/mt) 1,432</p> <p>Jx (cm⁴) 29,52</p> <p>Jy (cm⁴) 15,19</p>	<p>Sistem Kodu 5001</p> <p>Ağırlık (kg/mt) 1,757</p> <p>Jx (cm⁴) 74,95</p> <p>Jy (cm⁴) 22,10</p>	<p>Sistem Kodu 5002</p> <p>Ağırlık (kg/mt) 1,974</p> <p>Jx (cm⁴) 121,00</p> <p>Jy (cm⁴) 26,71</p>
<p>Sistem Kodu 5003*</p> <p>Ağırlık (kg/mt) 2,190</p> <p>Jx (cm⁴) 181,51</p> <p>Jy (cm⁴) 31,32</p>	<p>Sistem Kodu 5004*</p> <p>Ağırlık (kg/mt) 1,620</p> <p>Jx (cm⁴) 33,34</p> <p>Jy (cm⁴) 16,30</p>	<p>Sistem Kodu 5005*</p> <p>Ağırlık (kg/mt) 1,945</p> <p>Jx (cm⁴) 81,35</p> <p>Jy (cm⁴) 23,21</p>
<p>Sistem Kodu 5006</p> <p>Ağırlık (kg/mt) 2,160</p> <p>Jx (cm⁴) 130,50</p> <p>Jy (cm⁴) 27,82</p>	<p>Sistem Kodu 5007*</p> <p>Ağırlık (kg/mt) 2,379</p> <p>Jx (cm⁴) 195,40</p> <p>Jy (cm⁴) 32,44</p>	<p>Sistem Kodu 5008</p> <p>Ağırlık (kg/mt) 2,785</p> <p>Jx (cm⁴) 331,31</p> <p>Jy (cm⁴) 36,90</p>
<p>Sistem Kodu 5009*</p> <p>Ağırlık (kg/mt) 3,095</p> <p>Jx (cm⁴) 463,00</p> <p>Jy (cm⁴) 43,19</p>	<p>Sistem Kodu 5041</p> <p>Ağırlık (kg/mt) 3,298</p> <p>Jx (cm⁴) 420,00</p> <p>Jy (cm⁴) 31,12</p>	<p>Sistem Kodu 5010</p> <p>Ağırlık (kg/mt) 1,202</p> <p>Jx (cm⁴) 26,63</p> <p>Jy (cm⁴) 12,30</p>
<p>Sistem Kodu 5011</p> <p>Ağırlık (kg/mt) 1,446</p> <p>Jx (cm⁴) 63,84</p> <p>Jy (cm⁴) 17,59</p>	<p>Sistem Kodu 5012</p> <p>Ağırlık (kg/mt) 1,609</p> <p>Jx (cm⁴) 102,18</p> <p>Jy (cm⁴) 21,11</p>	<p>Sistem Kodu 5013</p> <p>Ağırlık (kg/mt) 1,772</p> <p>Jx (cm⁴) 152,30</p> <p>Jy (cm⁴) 24,64</p>
<p>Sistem Kodu 5014*</p> <p>Ağırlık (kg/mt) 1,408</p> <p>Jx (cm⁴) 29,37</p> <p>Jy (cm⁴) 13,86</p>	<p>Sistem Kodu 5015</p> <p>Ağırlık (kg/mt) 1,657</p> <p>Jx (cm⁴) 70,14</p> <p>Jy (cm⁴) 19,15</p>	<p>Sistem Kodu 5016</p> <p>Ağırlık (kg/mt) 1,820</p> <p>Jx (cm⁴) 111,67</p> <p>Jy (cm⁴) 22,69</p>
<p>Sistem Kodu 5017</p> <p>Ağırlık (kg/mt) 1,983</p> <p>Jx (cm⁴) 166,23</p> <p>Jy (cm⁴) 26,21</p>	<p>Sistem Kodu 5211</p> <p>Ağırlık (kg/mt) 1,654</p> <p>Jx (cm⁴) 20,32</p> <p>Jy (cm⁴) 71,41</p>	<p>Sistem Kodu 5212</p> <p>Ağırlık (kg/mt) 1,850</p> <p>Jx (cm⁴) 24,50</p> <p>Jy (cm⁴) 114,94</p>

<p>Sistem Kodu 5213</p> <p>Ağırlık (kg/mt) 2,045</p> <p>Jx (cm⁴) 28,69</p> <p>Jy (cm⁴) 172,01</p>	<p>Sistem Kodu 5018*</p> <p>Ağırlık (kg/mt) 1,156</p> <p>Jx (cm⁴) 13,74</p> <p>Jy (cm⁴) 3,56</p>	<p>Sistem Kodu 5019</p> <p>Ağırlık (kg/mt) 0,930</p> <p>Jx (cm⁴) 11,80</p> <p>Jy (cm⁴) 3,16</p>
<p>Sistem Kodu 5020*</p> <p>Ağırlık (kg/mt) 0,848</p> <p>Jx (cm⁴) 10,93</p> <p>Jy (cm⁴) 2,98</p>	<p>Sistem Kodu 5021</p> <p>Ağırlık (kg/mt) 0,110</p>	<p>Sistem Kodu 5022</p> <p>Ağırlık (kg/mt) 0,660</p> <p>Jx (cm⁴) 11,18</p> <p>Jy (cm⁴) 1,07</p>
<p>Sistem Kodu 5024</p> <p>Ağırlık (kg/mt) 0,248</p>	<p>Sistem Kodu 5025</p> <p>Ağırlık (kg/mt) 0,296</p>	<p>Sistem Kodu 5026</p> <p>Ağırlık (kg/mt) 0,325</p>
<p>Sistem Kodu 5027</p> <p>Ağırlık (kg/mt) 0,183</p>	<p>Sistem Kodu 5031</p> <p>Ağırlık (kg/mt) 0,211</p>	<p>Sistem Kodu 5033</p> <p>Ağırlık (kg/mt) 1,223</p>
<p>Sistem Kodu 5039*</p> <p>Ağırlık (kg/mt) 0,558</p>	<p>Sistem Kodu 5023*</p> <p>Ağırlık (kg/mt) 0,203</p>	<p>Sistem Kodu 9009</p> <p>Ağırlık (kg/mt) 0,123</p>
<p>Sistem Kodu 5028</p> <p>Ağırlık (kg/mt) 1,336</p>	<p>Sistem Kodu 5029</p> <p>Ağırlık (kg/mt) 3,683</p>	<p>Sistem Kodu 5042</p> <p>Ağırlık (kg/mt) 3,029</p>
<p>Sistem Kodu 5030</p> <p>Ağırlık (kg/mt) 2,299</p>	<p>Sistem Kodu 5040*</p> <p>Ağırlık (kg/mt) 3,729</p>	<p>Sistem Kodu 5036*</p> <p>Ağırlık (kg/mt) 0,893</p>

<p>Sistem Kodu 5110</p> <p>Ağırlık (kg/mt) 1,128</p> <p>Jx (cm⁴) 19,17</p> <p>Jy (cm⁴) 12,18</p>	<p>Sistem Kodu 5101</p> <p>Ağırlık (kg/mt) 1,351</p> <p>Jx (cm⁴) 52,63</p> <p>Jy (cm⁴) 17,47</p>	<p>Sistem Kodu 5100</p> <p>Ağırlık (kg/mt) 2,314</p> <p>Jx (cm⁴) 231,45</p> <p>Jy (cm⁴) 35,88</p>
<p>Sistem Kodu 5022</p> <p>Ağırlık (kg/mt) 0,660</p> <p>Jx (cm⁴) 11,18</p> <p>Jy (cm⁴) 1,07</p>	<p>Sistem Kodu 5019</p> <p>Ağırlık (kg/mt) 0,930</p> <p>Jx (cm⁴) 11,80</p> <p>Jy (cm⁴) 3,16</p>	<p>Sistem Kodu 5042</p> <p>Ağırlık (kg/mt) 3,029</p>
<p>Sistem Kodu 5027*</p> <p>Ağırlık (kg/mt) 0,183</p>	<p>Sistem Kodu 5037</p> <p>Ağırlık (kg/mt) 0,231</p>	<p>Sistem Kodu 5038</p> <p>Ağırlık (kg/mt) ,0369</p>
<p>Sistem Kodu 5021</p> <p>Ağırlık (kg/mt) 0,110</p>	<p>Sistem Kodu 5115*</p> <p>Ağırlık (kg/mt) ,0166</p>	<p>Sistem Kodu 9009</p> <p>Ağırlık (kg/mt) 0,123</p>
<p>Sistem Kodu 5028</p> <p>Ağırlık (kg/mt) 1,336</p>	<p>Sistem Kodu 5030</p> <p>Ağırlık (kg/mt) 2,299</p>	<p>Sistem Kodu 903</p> <p>Ağırlık (kg/mt) 0,172</p>
<p>Sistem Kodu 900</p> <p>Ağırlık (kg/mt) 0,190</p>	<p>Sistem Kodu 901</p> <p>Ağırlık (kg/mt) 0,225</p>	<p>Sistem Kodu 902</p> <p>Ağırlık (kg/mt) 0,131</p>
<p>Sistem Kodu 800</p> <p>Ağırlık (kg/mt) 0,339</p>	<p>Sistem Kodu 801</p> <p>Ağırlık (kg/mt) 0,340</p>	<p>Sistem Kodu 802</p> <p>Ağırlık (kg/mt) 0,292</p>

AKSAL

Alüminyum

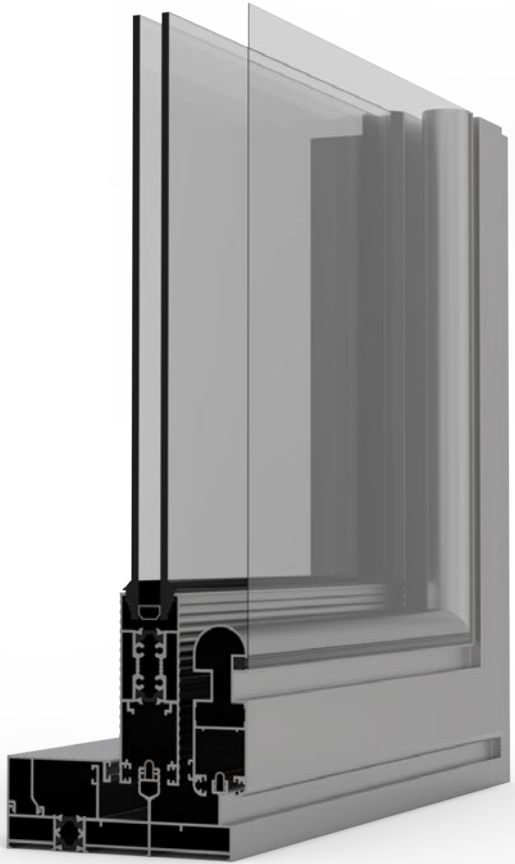

<p>Sistem Kodu 7500</p> <p>Ağırlık (kg/mt) 1,228</p> <p>Jx (cm⁴) 7,25</p> <p>Jy (cm⁴) 31,50</p>	<p>Sistem Kodu 7501</p> <p>Ağırlık (kg/mt) 1,600</p> <p>Jx (cm⁴) 9,05</p> <p>Jy (cm⁴) 72,30</p>	<p>Sistem Kodu 7502</p> <p>Ağırlık (kg/mt) 1,144</p> <p>Jx (cm⁴) 5,20</p> <p>Jy (cm⁴) 34,85</p>
<p>Sistem Kodu 7503</p> <p>Ağırlık (kg/mt) 1,536</p> <p>Jx (cm⁴) 7,15</p> <p>Jy (cm⁴) 73,63</p>	<p>Sistem Kodu 7504</p> <p>Ağırlık (kg/mt) 1,771</p> <p>Jx (cm⁴) 10,42</p> <p>Jy (cm⁴) 100,66</p>	<p>Sistem Kodu 7505*</p> <p>Ağırlık (kg/mt) 2,128</p> <p>Jx (cm⁴) 12,17</p> <p>Jy (cm⁴) 179,17</p>
<p>Sistem Kodu 7506</p> <p>Ağırlık (kg/mt) 1,488</p> <p>Jx (cm⁴) 28,15</p> <p>Jy (cm⁴) 7,43</p>	<p>Sistem Kodu 7508</p> <p>Ağırlık (kg/mt) 1,179</p> <p>Jx (cm⁴) 16,26</p> <p>Jy (cm⁴) 6,52</p>	<p>Sistem Kodu 7624</p> <p>Ağırlık (kg/mt) 1,094</p> <p>Jx (cm⁴) 28,60</p> <p>Jy (cm⁴) 4,70</p>
<p>Sistem Kodu 7406</p> <p>Ağırlık (kg/mt) 0,648</p> <p>Jx (cm⁴) 5,15</p> <p>Jy (cm⁴) 3,14</p>	<p>Sistem Kodu 7625</p> <p>Ağırlık (kg/mt) 1,122</p> <p>Jx (cm⁴) 27,07</p> <p>Jy (cm⁴) 6,64</p>	<p>Sistem Kodu 7511</p> <p>Ağırlık (kg/mt) 1,258</p> <p>Jx (cm⁴) 16,80</p> <p>Jy (cm⁴) 6,61</p>
<p>Sistem Kodu 7611</p> <p>Ağırlık (kg/mt) 0,992</p> <p>Jx (cm⁴) 20,40</p> <p>Jy (cm⁴) 4,10</p>	<p>Sistem Kodu 7612*</p> <p>Ağırlık (kg/mt) 0,532</p> <p>Jx (cm⁴) 9,38</p> <p>Jy (cm⁴) 1,77</p>	<p>Sistem Kodu 4906</p> <p>Ağırlık (kg/mt) 0,679</p> <p>Jx (cm⁴) 7,80</p> <p>Jy (cm⁴) 3,33</p>
<p>Sistem Kodu 7613*</p> <p>Ağırlık (kg/mt) 0,528</p> <p>Jx (cm⁴) 9,07</p> <p>Jy (cm⁴) 1,16</p>	<p>Sistem Kodu 7614</p> <p>Ağırlık (kg/mt) 0,529</p> <p>Jx (cm⁴) 2,35</p> <p>Jy (cm⁴) 0,96</p>	<p>Sistem Kodu 7615*</p> <p>Ağırlık (kg/mt) 0,363</p> <p>Jx (cm⁴) 2,84</p> <p>Jy (cm⁴) 0,75</p>
<p>Sistem Kodu 4915</p> <p>Ağırlık (kg/mt) 0,176</p>	<p>Sistem Kodu 236</p> <p>Ağırlık (kg/mt) 0,091</p>	<p>Sistem Kodu 7616</p> <p>Ağırlık (kg/mt) 0,414</p> <p>Jx (cm⁴) 0,92</p> <p>Jy (cm⁴) 6,30</p>

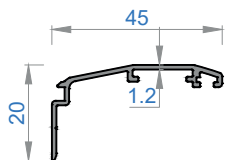
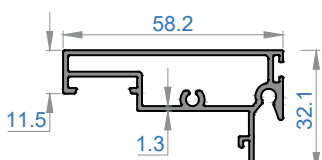
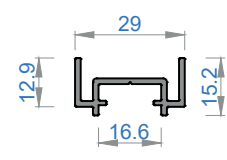
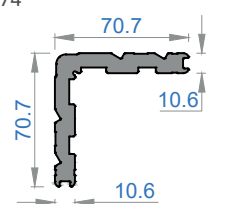
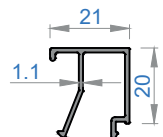
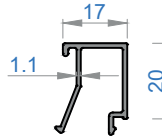
<p>Sistem Kodu 7617 Ağırlık (kg/mt) 0,273 Statik Statik Jx (cm⁴) 2,58 Jy (cm⁴) 0,21</p> 	<p>Sistem Kodu 7618 Ağırlık (kg/mt) 0,709 Statik Statik Jx (cm⁴) 9,23 Jy (cm⁴) 1,40</p> 	<p>Sistem Kodu 7619 Ağırlık (kg/mt) 0,289</p> 
<p>Sistem Kodu 4499 Ağırlık (kg/mt) 3,074</p> 	<p>Sistem Kodu 7620 Ağırlık (kg/mt) 0,238</p> 	<p>Sistem Kodu 7621* Ağırlık (kg/mt) 0,225</p> 

<p>Sistem Kodu 7600-7601</p> <p>Ağırlık (kg/mt) 1,485</p> <p>Statik J_x (cm⁴) 7,98</p> <p>Statik J_y (cm⁴) 32,13</p>	<p>Sistem Kodu 7602-7601</p> <p>Ağırlık (kg/mt) 1,824</p> <p>Statik J_x (cm⁴) 9,60</p> <p>Statik J_y (cm⁴) 72,80</p>	<p>Sistem Kodu 7603-7604</p> <p>Ağırlık (kg/mt) 1,395</p> <p>Statik J_x (cm⁴) 5,50</p> <p>Statik J_y (cm⁴) 36,30</p>
<p>Sistem Kodu 7605-7604</p> <p>Ağırlık (kg/mt) 1,786</p> <p>Statik J_x (cm⁴) 7,45</p> <p>Statik J_y (cm⁴) 78,6</p>	<p>Sistem Kodu 7600-7606-7601</p> <p>Ağırlık (kg/mt) 2,262</p> <p>Statik J_x (cm⁴) 11,68</p> <p>Statik J_y (cm⁴) 107,25</p>	<p>Sistem Kodu 7602-7606-7601</p> <p>Ağırlık (kg/mt) 2,601</p> <p>Statik J_x (cm⁴) 13,28</p> <p>Statik J_y (cm⁴) 185,05</p>
<p>Sistem Kodu 7607-7607</p> <p>Ağırlık (kg/mt) 1,581</p> <p>Statik J_x (cm⁴) 27,82</p> <p>Statik J_y (cm⁴) 7,43</p>	<p>Sistem Kodu 7608-7608</p> <p>Ağırlık (kg/mt) 1,272</p> <p>Statik J_x (cm⁴) 16,10</p> <p>Statik J_y (cm⁴) 6,52</p>	<p>Sistem Kodu 7622</p> <p>Ağırlık (kg/mt) 0,558</p> <p>Statik J_x (cm⁴) 3,66</p> <p>Statik J_y (cm⁴) 2,92</p>
<p>Sistem Kodu 7623</p> <p>Ağırlık (kg/mt) 1,005</p> <p>Statik J_x (cm⁴) 23,83</p> <p>Statik J_y (cm⁴) 4,50</p>	<p>Sistem Kodu 7611</p> <p>Ağırlık (kg/mt) 0,992</p> <p>Statik J_x (cm⁴) 20,40</p> <p>Statik J_y (cm⁴) 4,10</p>	<p>Sistem Kodu 7612*</p> <p>Ağırlık (kg/mt) 0,532</p> <p>Statik J_x (cm⁴) 9,38</p> <p>Statik J_y (cm⁴) 1,77</p>
<p>Sistem Kodu 4906</p> <p>Ağırlık (kg/mt) 0,679</p> <p>Statik J_x (cm⁴) 7,80</p> <p>Statik J_y (cm⁴) 3,33</p>	<p>Sistem Kodu 7613</p> <p>Ağırlık (kg/mt) 0,528</p> <p>Statik J_x (cm⁴) 9,07</p> <p>Statik J_y (cm⁴) 1,16</p>	<p>Sistem Kodu 7614</p> <p>Ağırlık (kg/mt) 0,529</p> <p>Statik J_x (cm⁴) 2,35</p> <p>Statik J_y (cm⁴) 0,96</p>
<p>Sistem Kodu 7615</p> <p>Ağırlık (kg/mt) 0,363</p> <p>Statik J_x (cm⁴) 2,84</p> <p>Statik J_y (cm⁴) 0,75</p>	<p>Sistem Kodu 7616</p> <p>Ağırlık (kg/mt) 0,414</p> <p>Statik J_x (cm⁴) 0,92</p> <p>Statik J_y (cm⁴) 6,30</p>	<p>Sistem Kodu 7617</p> <p>Ağırlık (kg/mt) 0,273</p> <p>Statik J_x (cm⁴) 2,58</p> <p>Statik J_y (cm⁴) 0,21</p>
<p>Sistem Kodu 7618</p> <p>Ağırlık (kg/mt) 0,709</p> <p>Statik J_x (cm⁴) 9,23</p> <p>Statik J_y (cm⁴) 1,40</p>	<p>Sistem Kodu 4915</p> <p>Ağırlık (kg/mt) 0,176</p>	<p>Sistem Kodu 7619</p> <p>Ağırlık (kg/mt) 0,289</p>

<p>Sistem Kodu 7400</p> <p>Ağırlık (kg/mt) 1,259</p> <p>Statik Jx (cm⁴) 7,45</p> <p>Statik Jy (cm⁴) 32,10</p>	<p>Sistem Kodu 7401</p> <p>Ağırlık (kg/mt) 1,653</p> <p>Statik Jx (cm⁴) 10,00</p> <p>Statik Jy (cm⁴) 75,40</p>	<p>Sistem Kodu 7402</p> <p>Ağırlık (kg/mt) 1,172</p> <p>Statik Jx (cm⁴) 5,36</p> <p>Statik Jy (cm⁴) 36,00</p>
<p>Sistem Kodu 7403</p> <p>Ağırlık (kg/mt) 1,584</p> <p>Statik Jx (cm⁴) 7,90</p> <p>Statik Jy (cm⁴) 76,25</p>	<p>Sistem Kodu 7509</p> <p>Ağırlık (kg/mt) 1,052</p> <p>Statik Jx (cm⁴) 27,54</p> <p>Statik Jy (cm⁴) 3,00</p>	<p>Sistem Kodu 7507</p> <p>Ağırlık (kg/mt) 0,610</p> <p>Statik Jx (cm⁴) 4,55</p> <p>Statik Jy (cm⁴) 1,61</p>
<p>Sistem Kodu 7510</p> <p>Ağırlık (kg/mt) 1,122</p> <p>Statik Jx (cm⁴) 24,54</p> <p>Statik Jy (cm⁴) 3,78</p>	<p>Sistem Kodu 7614</p> <p>Ağırlık (kg/mt) 0,529</p> <p>Statik Jx (cm⁴) 2,35</p> <p>Statik Jy (cm⁴) 0,96</p>	<p>Sistem Kodu 7616</p> <p>Ağırlık (kg/mt) 0,414</p> <p>Statik Jx (cm⁴) 0,92</p> <p>Statik Jy (cm⁴) 6,30</p>
<p>Sistem Kodu 7513</p> <p>Ağırlık (kg/mt) 0,967</p> <p>Statik Jx (cm⁴)</p> <p>Statik Jy (cm⁴)</p>	<p>Sistem Kodu 7514</p> <p>Ağırlık (kg/mt) 1,227</p> <p>Statik Jx (cm⁴)</p> <p>Statik Jy (cm⁴)</p>	<p>Sistem Kodu 7611</p> <p>Ağırlık (kg/mt) 0,992</p> <p>Statik Jx (cm⁴) 20,40</p> <p>Statik Jy (cm⁴) 4,10</p>
<p>Sistem Kodu 7612*</p> <p>Ağırlık (kg/mt) 0,532</p> <p>Statik Jx (cm⁴) 9,38</p> <p>Statik Jy (cm⁴) 1,77</p>	<p>Sistem Kodu 4906</p> <p>Ağırlık (kg/mt) 0,679</p> <p>Statik Jx (cm⁴) 7,80</p> <p>Statik Jy (cm⁴) 3,33</p>	<p>Sistem Kodu 7613*</p> <p>Ağırlık (kg/mt) 0,528</p> <p>Statik Jx (cm⁴) 9,07</p> <p>Statik Jy (cm⁴) 1,16</p>
<p>Sistem Kodu 7617</p> <p>Ağırlık (kg/mt) 0,273</p> <p>Statik Jx (cm⁴) 2,58</p> <p>Statik Jy (cm⁴) 0,21</p>	<p>Sistem Kodu 7618</p> <p>Ağırlık (kg/mt) 0,709</p> <p>Statik Jx (cm⁴) 9,23</p> <p>Statik Jy (cm⁴) 1,40</p>	<p>Sistem Kodu 7609</p> <p>Ağırlık (kg/mt) 0,491</p> <p>Statik Jx (cm⁴) 3,38</p> <p>Statik Jy (cm⁴) 0,87</p>
<p>Sistem Kodu 7610</p> <p>Ağırlık (kg/mt) 0,933</p> <p>Statik Jx (cm⁴) 21,66</p> <p>Statik Jy (cm⁴) 2,42</p>	<p>Sistem Kodu 7620</p> <p>Ağırlık (kg/mt) 0,238</p>	<p>Sistem Kodu 7621*</p> <p>Ağırlık (kg/mt) 0,225</p>

AKSAL

Alüminyum

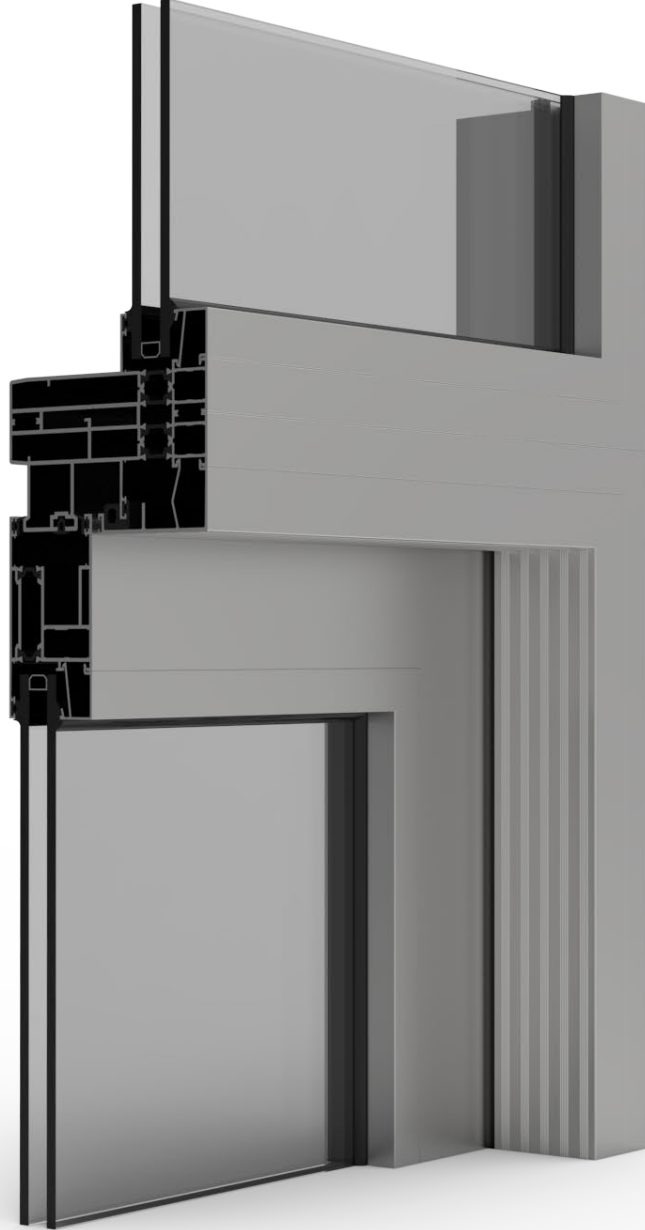

<p>Sistem Kodu 9102-9103</p> <p>Ağırlık (kg/mt) 2,673 Jx (cm⁴) 22,41 Jy (cm⁴) 130,28</p>	<p>Sistem Kodu 9200-9201*</p> <p>Ağırlık (kg/mt) 3,268 Jx (cm⁴) 26,89 Jy (cm⁴) 211,34</p>	<p>Sistem Kodu 9215-9103*</p> <p>Ağırlık (kg/mt) 1,954 Jx (cm⁴) 6,87 Jy (cm⁴) 101,41</p>
<p>Sistem Kodu 9200-9203</p> <p>Ağırlık (kg/mt) 3,746 Jx (cm⁴) 32,00 Jy (cm⁴) 337,60</p>	<p>Sistem Kodu 9104-9105</p> <p>Ağırlık (kg/mt) 1,631 Jx (cm⁴) 27,94 Jy (cm⁴) 21,54</p>	<p>Sistem Kodu 9100-9101</p> <p>Ağırlık (kg/mt) 2,185 Jx (cm⁴) 42,91 Jy (cm⁴) 31,94</p>
<p>Sistem Kodu 9106</p> <p>Ağırlık (kg/mt) 0,765 Jx (cm⁴) 2,27 Jy (cm⁴) 13,83</p>	<p>Sistem Kodu 9107</p> <p>Ağırlık (kg/mt) 0,375</p>	<p>Sistem Kodu 9216-9217</p> <p>Ağırlık (kg/mt) 1,170 Jx (cm⁴) 13,90 Jy (cm⁴) 3,00</p>
<p>Sistem Kodu 9108</p> <p>Ağırlık (kg/mt) 0,486 Jx (cm⁴) 1,66 Jy (cm⁴) 10,51</p>	<p>Sistem Kodu 7611</p> <p>Ağırlık (kg/mt) 0,992 Jx (cm⁴) 20,40 Jy (cm⁴) 4,10</p>	<p>Sistem Kodu 7612*</p> <p>Ağırlık (kg/mt) 0,532 Jx (cm⁴) 9,38 Jy (cm⁴) 1,77</p>
<p>Sistem Kodu 4906</p> <p>Ağırlık (kg/mt) 0,680 Jx (cm⁴) 7,80 Jy (cm⁴) 3,33</p>	<p>Sistem Kodu 9114*</p> <p>Ağırlık (kg/mt) 0,216</p>	<p>Sistem Kodu 9113</p> <p>Ağırlık (kg/mt) 0,812</p>
<p>Sistem Kodu 9109</p> <p>Ağırlık (kg/mt) 2,551</p>	<p>Sistem Kodu 4499</p> <p>Ağırlık (kg/mt) 3,062</p>	<p>Sistem Kodu 9010</p> <p>Ağırlık (kg/mt) 0,309</p>
<p>Sistem Kodu 9117*</p> <p>Ağırlık (kg/mt) 0,288</p>	<p>Sistem Kodu 9118*</p> <p>Ağırlık (kg/mt) 0,282</p>	<p>Sistem Kodu 9119*</p> <p>Ağırlık (kg/mt) 0,275</p>
<p>Sistem Kodu 9110*</p> <p>Ağırlık (kg/mt) 0,277</p>	<p>Sistem Kodu 9111*</p> <p>Ağırlık (kg/mt) 0,271</p>	<p>Sistem Kodu 9112*</p> <p>Ağırlık (kg/mt) 0,255</p>

AKSAL

Alüminyum



<p>Sistem Kodu 5500</p> <p>Ağırlık (kg/mt) 2,141</p> <p>Statik Jx (cm⁴) 256,60</p> <p>Statik Jy (cm⁴) 12,93</p>	<p>Sistem Kodu 5501</p> <p>Ağırlık (kg/mt) 3,853</p> <p>Statik Jx (cm⁴) 160,50</p> <p>Statik Jy (cm⁴) 586,75</p>	<p>Sistem Kodu 5502</p> <p>Ağırlık (kg/mt) 2,846</p> <p>Statik Jx (cm⁴) 209,15</p> <p>Statik Jy (cm⁴) 268,17</p>
<p>Sistem Kodu 5006</p> <p>Ağırlık (kg/mt) 2,161</p> <p>Statik Jx (cm⁴) 130,50</p> <p>Statik Jy (cm⁴) 27,82</p>	<p>Sistem Kodu 5505</p> <p>Ağırlık (kg/mt) 3,156</p> <p>Statik Jx (cm⁴) 181,90</p> <p>Statik Jy (cm⁴) 50,35</p>	<p>Sistem Kodu 5503</p> <p>Ağırlık (kg/mt) 0,459</p> <p>Statik Jx (cm⁴) 0,40</p> <p>Statik Jy (cm⁴) 16,61</p>
<p>Sistem Kodu 5026</p> <p>Ağırlık (kg/mt) 0,325</p>	<p>Sistem Kodu 5024</p> <p>Ağırlık (kg/mt) 0,248</p>	<p>Sistem Kodu 5504</p> <p>Ağırlık (kg/mt) 0,422</p>
<p>Sistem Kodu 5506</p> <p>Ağırlık (kg/mt) 0,449</p>	<p>Sistem Kodu 5507</p> <p>Ağırlık (kg/mt) 0,597</p>	<p>Sistem Kodu 236</p> <p>Ağırlık (kg/mt) 0,091</p>
<p>Sistem Kodu 5508</p> <p>Ağırlık (kg/mt) 0,706</p> <p>Statik Jx (cm⁴) 32,60</p> <p>Statik Jy (cm⁴) 1,20</p>	<p>Sistem Kodu 5509</p> <p>Ağırlık (kg/mt) 1,102</p> <p>Statik Jx (cm⁴) 38,52</p> <p>Statik Jy (cm⁴) 3,25</p>	<p>Sistem Kodu 5028</p> <p>Ağırlık (kg/mt) 1,336</p>

AKSAL

Alüminyum



<p>Sistem Kodu 5600 Ağırlık (kg/mt) 2,209</p>	<p>Sistem Kodu 5601 Ağırlık (kg/mt) 0,769</p>	<p>Sistem Kodu 5602 Ağırlık (kg/mt) 1,242</p>
<p>Sistem Kodu 5603 Ağırlık (kg/mt) 1,356</p>	<p>Sistem Kodu 5604 Ağırlık (kg/mt) 0,168</p>	<p>Sistem Kodu 5605 Ağırlık (kg/mt) 0,309</p>
<p>Sistem Kodu 5606 Ağırlık (kg/mt) 1,255</p>	<p>Sistem Kodu 5607 Ağırlık (kg/mt) 0,577</p>	<p>Sistem Kodu 5608 Ağırlık (kg/mt) 1,112</p>
<p>Sistem Kodu 5609 Ağırlık (kg/mt) 0,920</p>	<p>Sistem Kodu 5610 Ağırlık (kg/mt) 0,800</p>	<p>Sistem Kodu 5611 Ağırlık (kg/mt) 0,617</p>
<p>Sistem Kodu 5612 Ağırlık (kg/mt) 0,595</p>	<p>Sistem Kodu 5613 Ağırlık (kg/mt) 1,587</p>	

<p>Sistem Kodu 4800 Ağırlık (kg/mt) 1,641</p>	<p>Sistem Kodu 4807 Ağırlık (kg/mt) 1,693</p>	<p>Sistem Kodu 4853 Ağırlık (kg/mt) 1,271</p>
<p>Sistem Kodu 4852 Ağırlık (kg/mt) 1,215</p>	<p>Sistem Kodu 50113 Ağırlık (kg/mt) 1,379</p>	<p>Sistem Kodu 50114 Ağırlık (kg/mt) 1,330</p>
<p>Sistem Kodu 4801 Ağırlık (kg/mt) 1,250</p>	<p>Sistem Kodu 4808 Ağırlık (kg/mt) 1,277</p>	<p>Sistem Kodu 5147 Ağırlık (kg/mt) 1,520</p>
<p>Sistem Kodu 5148 Ağırlık (kg/mt) 1,463</p>	<p>Sistem Kodu 1606 Ağırlık (kg/mt) 0,507</p>	<p>Sistem Kodu 1607 Ağırlık (kg/mt) 0,418</p>
<p>Sistem Kodu 1605 Ağırlık (kg/mt) 0,769</p>	<p>Sistem Kodu 1608 Ağırlık (kg/mt) 0,327</p>	<p>Sistem Kodu 1609 Ağırlık (kg/mt) 0,869</p>
<p>Sistem Kodu 4824 Ağırlık (kg/mt) 0,585</p>	<p>Sistem Kodu 4825 Ağırlık (kg/mt) 0,548</p>	<p>Sistem Kodu 4820 Ağırlık (kg/mt) 0,440</p>
<p>Sistem Kodu 4822 Ağırlık (kg/mt) 0,496</p>	<p>Sistem Kodu 4829 Ağırlık (kg/mt) 0,702</p>	<p>Sistem Kodu 4830 Ağırlık (kg/mt) 0,464</p>

<p>Sistem Kodu 4873 Ağırlık (kg/mt) 1,346</p>	<p>Sistem Kodu 4870 Ağırlık (kg/mt) 0,789</p>	<p>Sistem Kodu 4872 Ağırlık (kg/mt) 0,607</p>
<p>Sistem Kodu 4877 Ağırlık (kg/mt) 0,392</p>	<p>Sistem Kodu 4843 Ağırlık (kg/mt) 0,527</p>	<p>Sistem Kodu 4871 Ağırlık (kg/mt) 0,632</p>
<p>Sistem Kodu 4876 Ağırlık (kg/mt) 0,303</p>	<p>Sistem Kodu 5084 Ağırlık (kg/mt) 0,243</p>	<p>Sistem Kodu 5085 Ağırlık (kg/mt) 0,481</p>
<p>Sistem Kodu 4851 Ağırlık (kg/mt) 1,540</p>	<p>Sistem Kodu 4850 Ağırlık (kg/mt) 1,498</p>	<p>Sistem Kodu 4804 Ağırlık (kg/mt) 0,777</p>
<p>Sistem Kodu 4854 Ağırlık (kg/mt) 0,835</p>	<p>Sistem Kodu 4803 Ağırlık (kg/mt) 0,500</p>	<p>Sistem Kodu 4827 Ağırlık (kg/mt) 0,451</p>
<p>Sistem Kodu 4826 Ağırlık (kg/mt) 0,224</p>	<p>Sistem Kodu 4805 Ağırlık (kg/mt) 0,140</p>	<p>Sistem Kodu 4806 Ağırlık (kg/mt) 0,227</p>
<p>Sistem Kodu 4809 Ağırlık (kg/mt) 0,250</p>	<p>Sistem Kodu 4810 Ağırlık (kg/mt) 0,167</p>	<p>Sistem Kodu 11003 Ağırlık (kg/mt) 0,272</p>

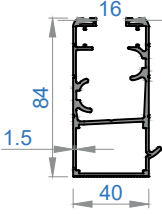
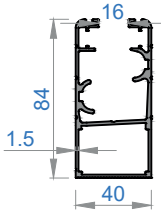
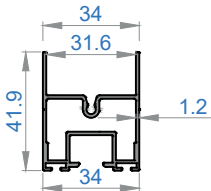
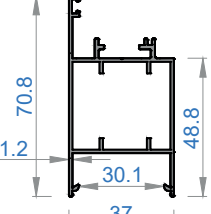
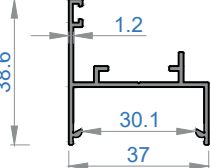
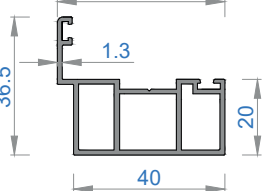
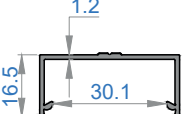
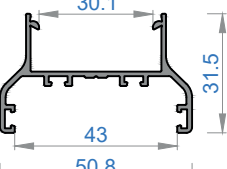
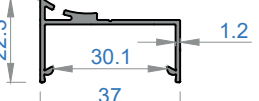
<p>Sistem Kodu 4851 Ağırlık (kg/mt) 1,540</p> 	<p>Sistem Kodu 4850 Ağırlık (kg/mt) 1,498</p> 	<p>Sistem Kodu 13774 Ağırlık (kg/mt) 0,656</p> 
<p>Sistem Kodu 4870 Ağırlık (kg/mt) 0,789</p> 	<p>Sistem Kodu 4877 Ağırlık (kg/mt) 0,392</p> 	<p>Sistem Kodu 4871 Ağırlık (kg/mt) 0,632</p> 
<p>Sistem Kodu 5084 Ağırlık (kg/mt) 0,243</p> 	<p>Sistem Kodu 5085 Ağırlık (kg/mt) 0,481</p> 	<p>Sistem Kodu 4876 Ağırlık (kg/mt) 0,303</p> 

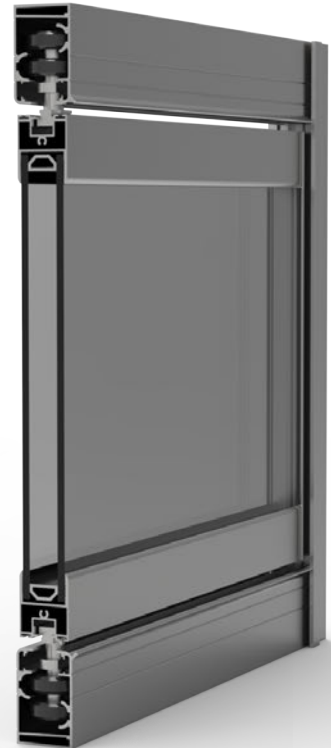

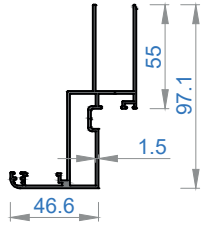
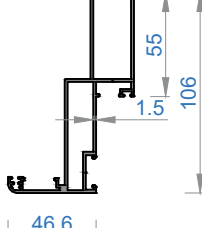
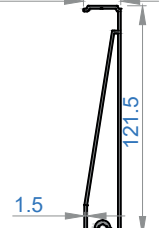
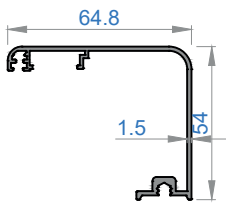
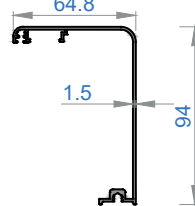
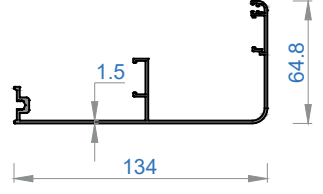
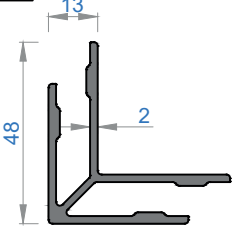
<p>Sistem Kodu 4600 Ağırlık (kg/mt) 1,291</p> 	<p>Sistem Kodu 4608 Ağırlık (kg/mt) 1,382</p> 	<p>Sistem Kodu 4601 Ağırlık (kg/mt) 1,109</p> 
<p>Sistem Kodu 4605 Ağırlık (kg/mt) 0,689</p> 	<p>Sistem Kodu 4606 Ağırlık (kg/mt) 0,851</p> 	<p>Sistem Kodu 4607 Ağırlık (kg/mt) 1,196</p> 
<p>Sistem Kodu 4609 Ağırlık (kg/mt) 0,937</p> 		

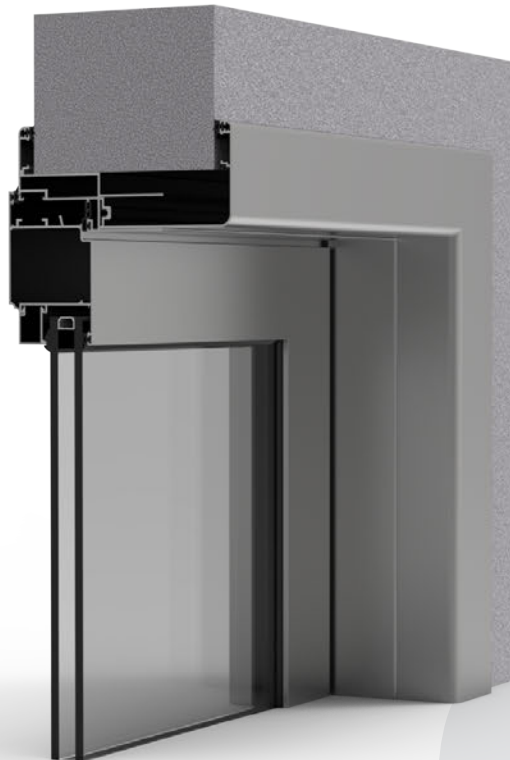

AKSAL

Alüminyum

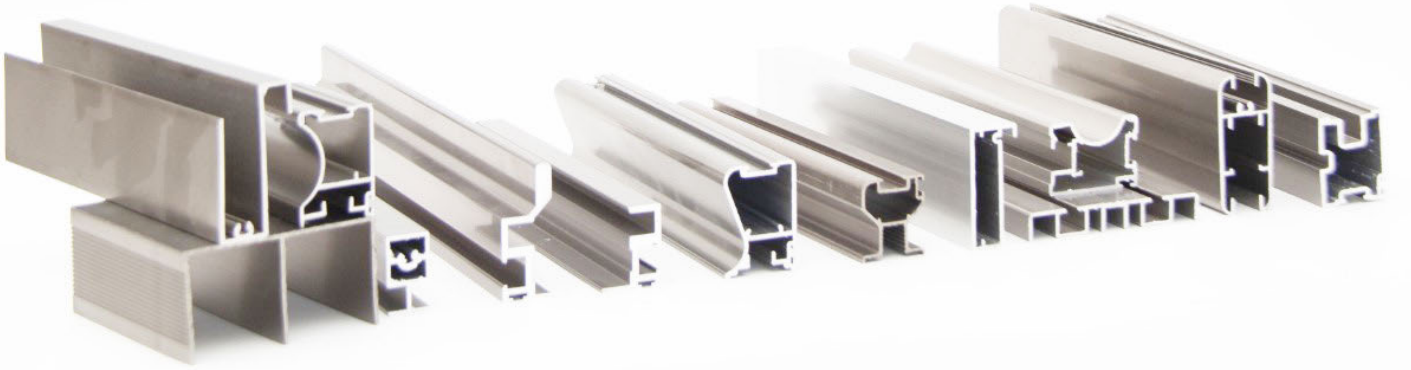

<p>Sistem Kodu 5258 Ağırlık (kg/mt) 0,352</p>	<p>Sistem Kodu 5261 Ağırlık (kg/mt) 0,301</p>	<p>Sistem Kodu 5262 Ağırlık (kg/mt) 0,236</p>
<p>Sistem Kodu 5227 Ağırlık (kg/mt) 0,222</p>	<p>Sistem Kodu 5263 Ağırlık (kg/mt) 0,255</p>	<p>Sistem Kodu 5259 Ağırlık (kg/mt) 0,290</p>
<p>Sistem Kodu 5264 Ağırlık (kg/mt) 0,100</p>	<p>Sistem Kodu 5256 Ağırlık (kg/mt) 0,336</p>	<p>Sistem Kodu 5260 Ağırlık (kg/mt) 0,740</p>
<p>Sistem Kodu 5265 Ağırlık (kg/mt) 0,365</p>	<p>Sistem Kodu 5266 Ağırlık (kg/mt) 0,227</p>	<p>Sistem Kodu 5267 Ağırlık (kg/mt) 0,165</p>
<p>Sistem Kodu 5268 Ağırlık (kg/mt) 0,198</p>	<p>Sistem Kodu 5269 Ağırlık (kg/mt) 0,226</p>	<p>Sistem Kodu 5270 Ağırlık (kg/mt) 0,154</p>
<p>Sistem Kodu 374 Ağırlık (kg/mt) 0,619</p>	<p>Sistem Kodu 5271 Ağırlık (kg/mt) 0,136</p>	

AKSAL

Alüminyum

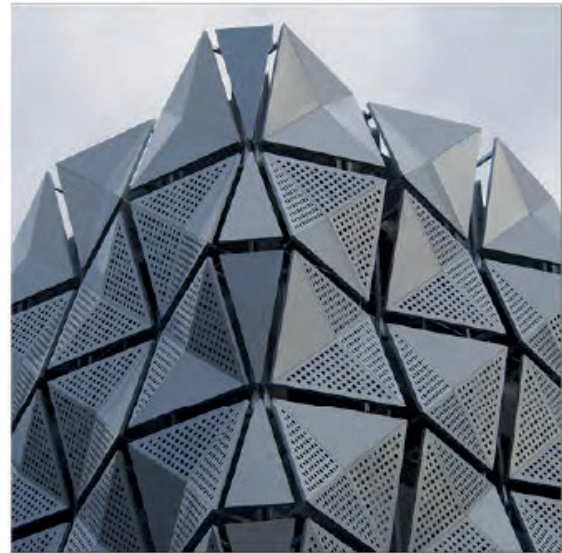
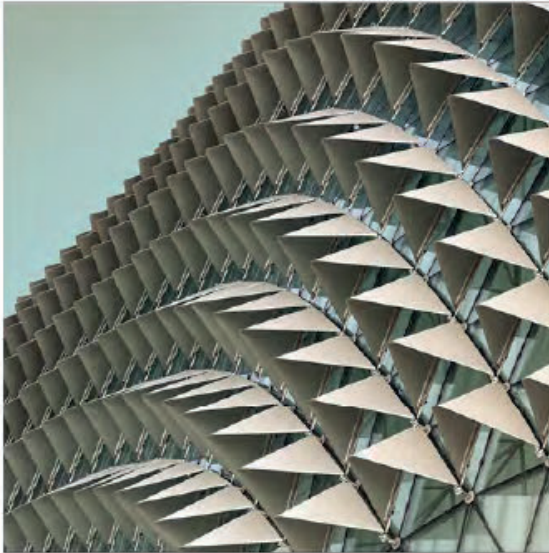
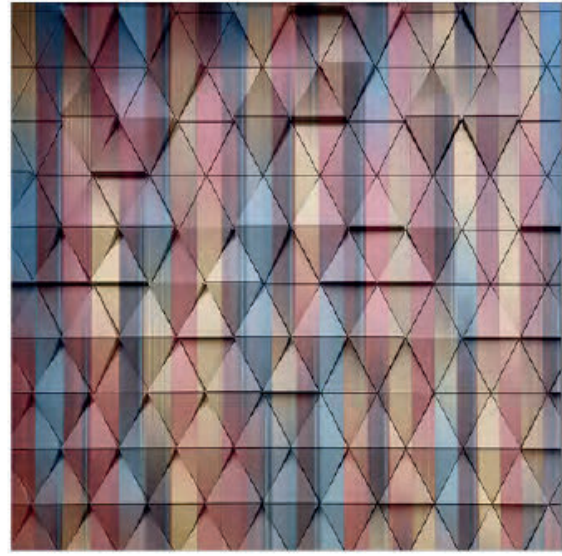
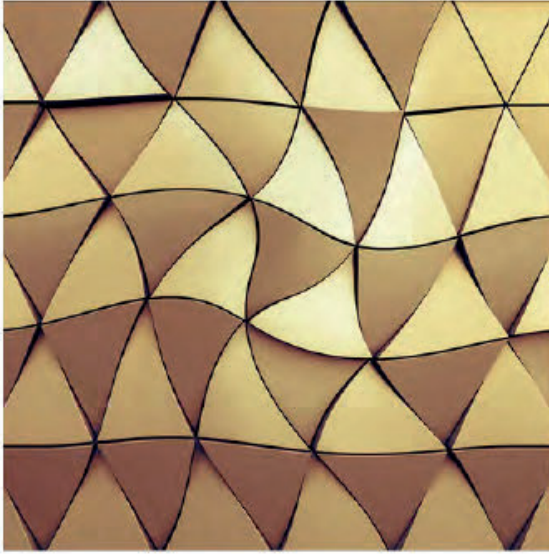

ARWIS BOND
CLASS BOND

PLUS⁺ BOND
FACE BOND

ARWIS BOND

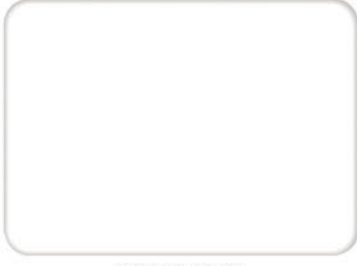

AWB-501
Beyaz // White

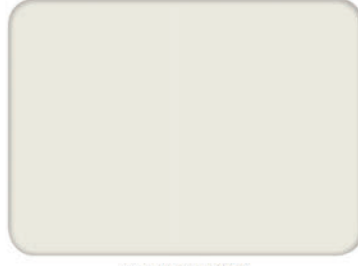

AWB-502
Krem // Cream

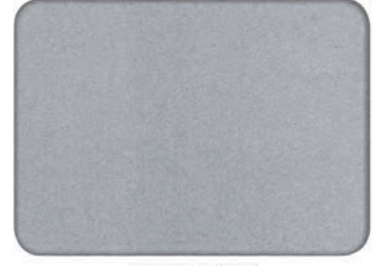

AWB-503
Gümüş // Silver



AWB-504
Siyah // Black

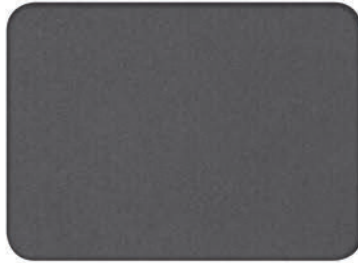

AWB-505
Koyu Gri // Dark Grey

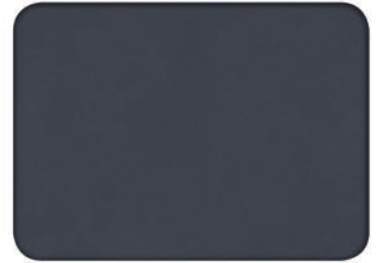

AWB-508
Grafit Gri // Graphite Grey

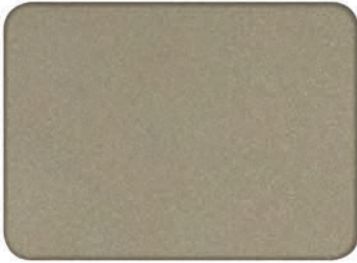

AWB-509
Açık Bronz // Light Bronze



AWB-513
Simli Siyah // Silvery Black



AWB-517
Ultra Marin Mavi // Ultra Marine Blue



AWB-531
İnce Altın Meşe // Golden Oak Fine Wood



AWB-532
Kalın Altın Meşe // Golden Oak Line Wood



AWB-535
Açık Altın Meşe // Kiefer Line Wood

FACE BOND

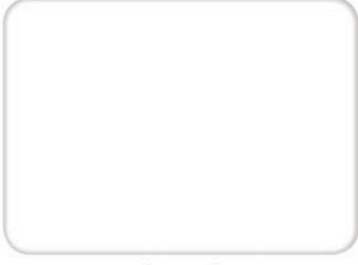

FCB-401
Beyaz // White

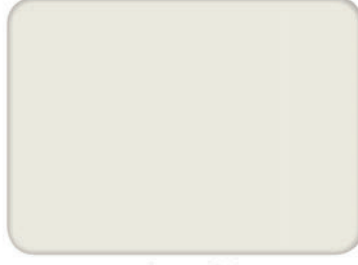

FCB-402
Krem // Cream

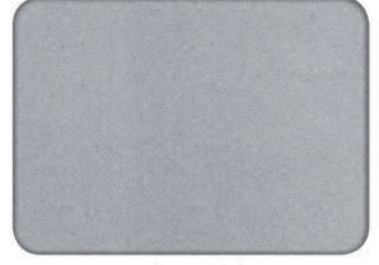

FCB-403
Gümüş // Silver



FCB-404
Siyah // Black



FCB-405
Koyu Gri // Dark Grey



FCB-406
Bakır // Cooper



FCB-407
Bordo // Burgundy

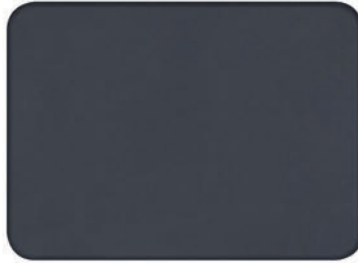

FCB-408
Grafit Gri // Graphite Grey

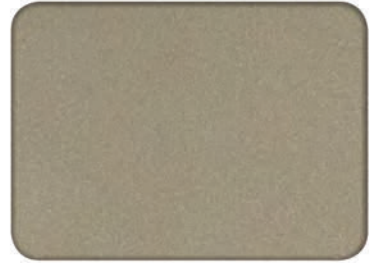

FCB-409
Açık Bronz // Light Bronze

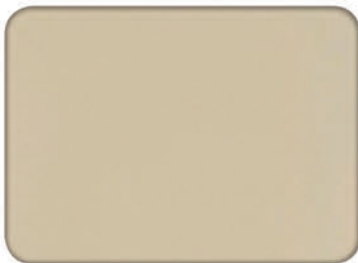

FCB-410
Kum Beji // Sand



FCB-411
Kırmızı // Red

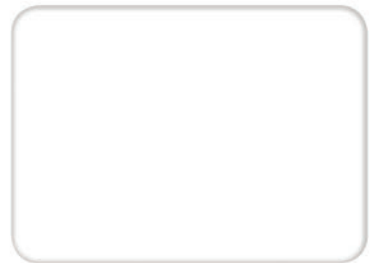

FCB-415
Nano Beyaz // Nano White

FACE BOND



FCB-420
Sarı // Yellow

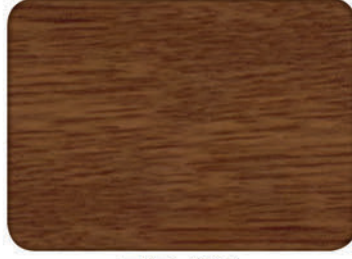

FCB-431
İnce Altın Meşe // Golden Oak Fine Wood

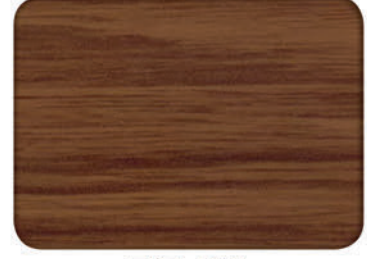

FCB-432
Kalın Altın Meşe // Golden Oak Line Wood

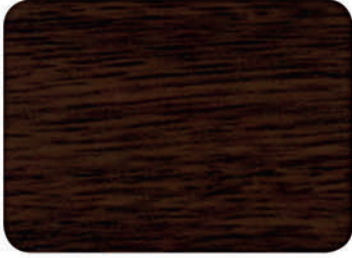

FCB-433
İnce Ceviz // Nussbaum

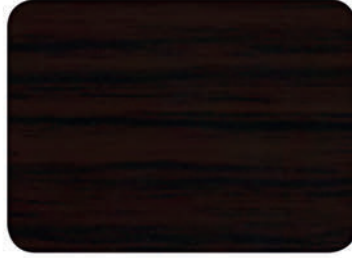

FCB-434
Kalın Maun // Mahogany



FCB-435
Açık Altın Meşe // Kiefer Line Wood

PLUS⁺ BOND

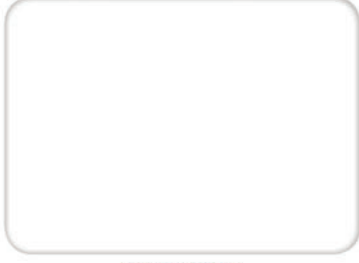

PLB-301
Beyaz // White

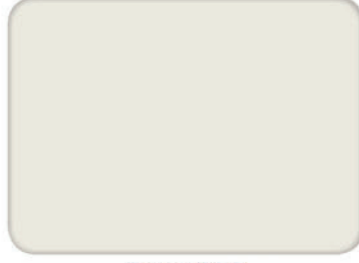

PLB-302
Krem // Cream

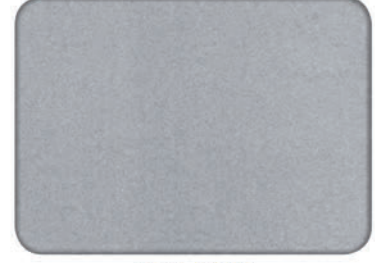

PLB-303
Gümüş // Silver

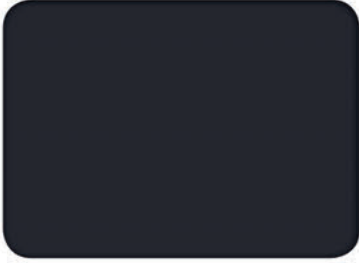

PLB-304
Siyah // Black

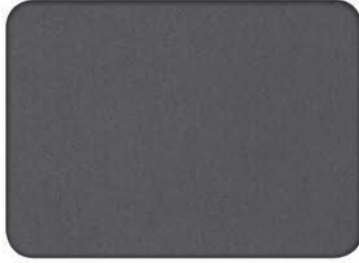

PLB-305
Koyu Gri // Dark Grey

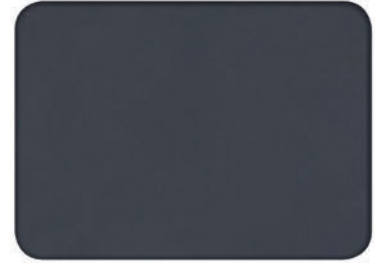

PLB-308
Grafit Gri // Graphite Grey

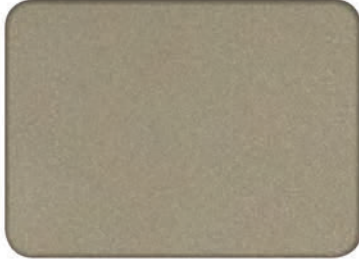

PLB-309
Açık Bronz // Light Bronze



PLB-311
Kırmızı // Red

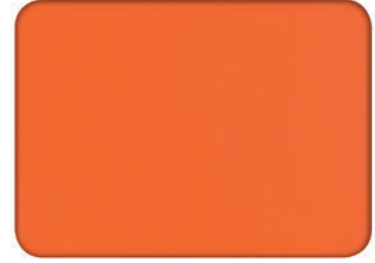

PLB-312
Pastel Turuncu // Pastel Orange

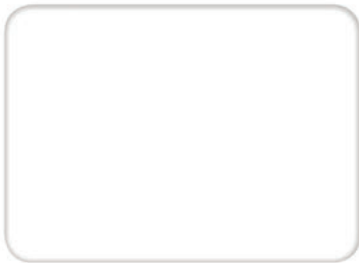

PLB-315
Nano Beyaz // Nano White



PLB-316
Yeşil // Green



PLB-317
Ultra Marin Mavi // Ultra Marine Blue

PLUS⁺ BOND

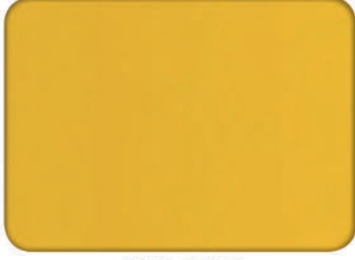

PLB-320
Sar / Yellow

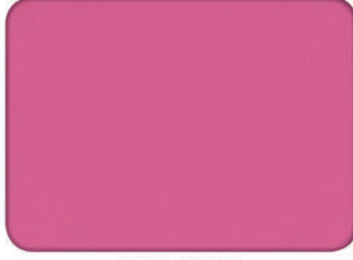

PLB-323
Pembe // Heather Wioled

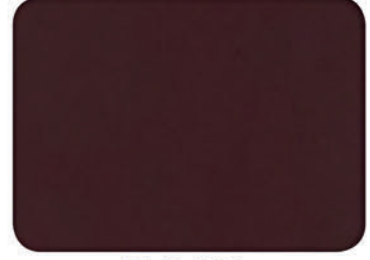

PLB-324
Çikolata // Chocolate Brown



PLB-331
İnce Altın Meşe // Golden Oak Fine Wood



PLB-332
Kalın Altın Meşe // Golden Oak Line Wood

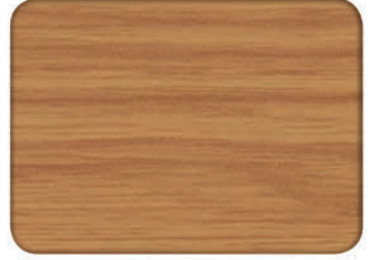

PLB-335
Açık Altın Meşe // Kiefer Line Wood



PLB-340
Gümüş Ayna // Silver Mirror



PLB-341
Altın Ayna // Golden Mirror



CLASS BOND

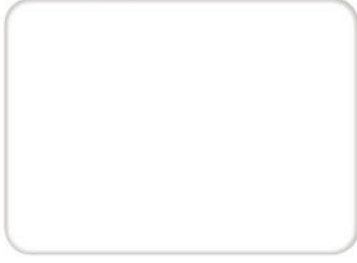

CSB-201
Beyaz // White

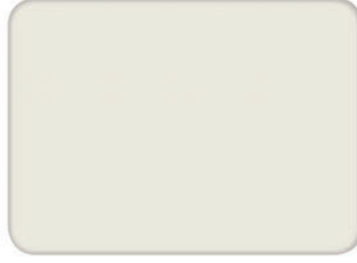

CSB-202
Krem // Cream

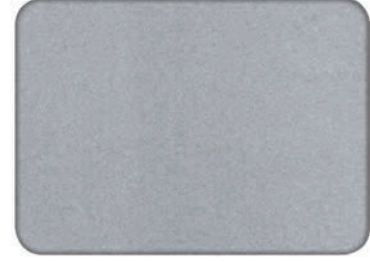

CSB-203
Gümüş // Silver



CSB-204
Siyah // Black



CSB-205
Koyu Gri // Dark Grey



CSB-206
Bakır // Cooper

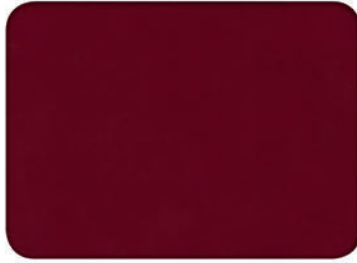

CSB-207
Bordo // Burgundy

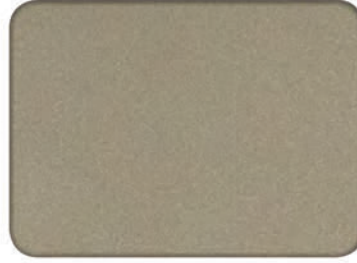

CSB-209
Açık Bronz // Light Bronze

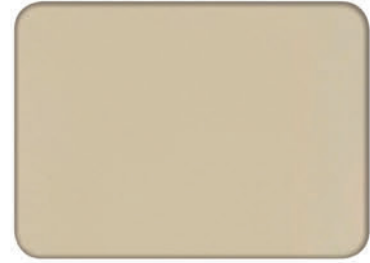

CSB-210
Kum Beji // Sand



CSB-211
Kırmızı // Red

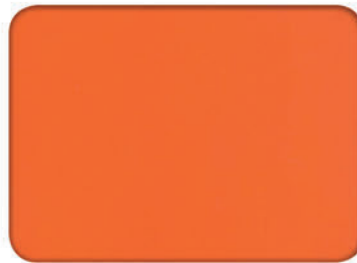

CSB-212
Pastel Turuncu // Pastel Orange



CSB-219
Derin Mavi // Deep Blue

CLASS BOND



CSB-220
Sar / Yellow



CSB-221
Açık Yeşil / Light Green



CSB-222
Koyu Yeşil / Deep Green



Kompozit Panel Ebatları

Panel Dimensions

Kompozit Panel Kalınlıkları Thickness Of Composite Panel	3 mm - 4 mm - 5 mm - 6 mm
Maksimum Üretim Boyu Maximum Production Length	10000 mm
Standart Üretim Ebatları Standard Panel Dimensions	1250 mm x 3200 mm x 4 mm 1500 mm x 3200 mm x 4 mm

Kullanılan Alüminyum Levhanın Mekanik Özellikleri

Mechanical Properties Of Aluminium

Çekme Mukavemeti (Rm) Tensile Strength (Rm)	186 MPa (min 130 Mpa)
Akma Mukavemeti (Rp 0.2) Yield Strength (Rp 0.2)	148 MPa (min 90 Mpa)
Yüzde Uzama (A50%) Elongation	6.8 (min 5)
Elastikiyet Modülü Modulus Of Elasticity	70000 MPa

- **Ulusan tarafından önerilen alt kontsrüksiyon ve montaj detayları uygulandıđı takdirde,**
If suggested sub construction and installation details are applied,
- **Kompozit paneller / Composite panels**
Arwisbond 20 yıl / Arwisbond 20 years
Facebond 20 yıl / Facebond 20 years
Plussbond 15 yıl garantilidir. / Plussbond 15 years are under guarantee.
- **Ton farkını engellemek için bir defada sipariş verilmesi önerilir.**
To ensure the color consistency, placing total requirement in one order is recommended.
- **Lütfen kompozit panelleri ok yönünde kullanınız.**
Please applicate all the panels the arrow direction.

Eđiklik

Bow

Panel Boyu Panel Length	< 1500 mm	max 5mm
Panel Boyu Panel Length	1500 mm - 3000 mm	max 7 mm
Panel Boyu Panel Length	< 3000 mm	max 10 mm

Üretim Toleransları

Tolerances

Kompozit Panel Kalınlığı Thickness Of Compositive Panel	± 0.2 mm
Kompozit Panel Geniřliđi Width Of Compositive Panel	± 2.0 mm
Kompozit Panel Boyu Length Of Compositive Panel	± 4.0 mm
Diagonal Fark Diagonal Difference	max 3.0 mm
Dođrusallık (Ende Ve Boyda) Linearity (On Width And Length)	± 0.2 mm
Uzama Miktarı (A%50) Elongation	1.2 mm/m (50° C)



Alüminyum Ekstrüzyon Profilleri

Aluminium Extrusion Profiles



AKSAL
Alüminyum

 Horozluhan Mah. Başkışla Sk. No:34 Selçuklu/KONYA

 +90 332 342 20 24

 bilgi@aksalaluminium.com

 www.aksalaluminium.com