

CAMLAMA SİSTEMLERİ

100S SÜRME CAM BALKON

100S SLIDING GLASS BALCONY

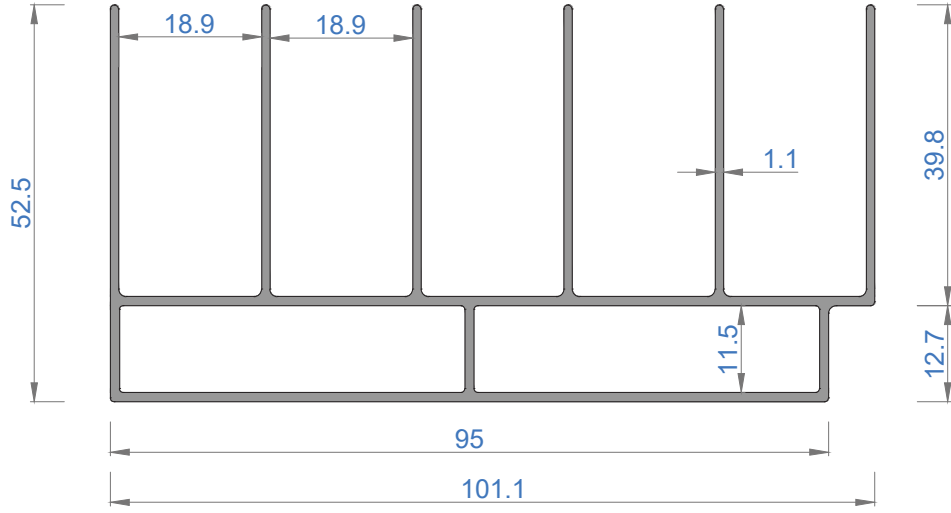

Sistem Kodu 50100

Ağırlık (kg/mt) 1,445

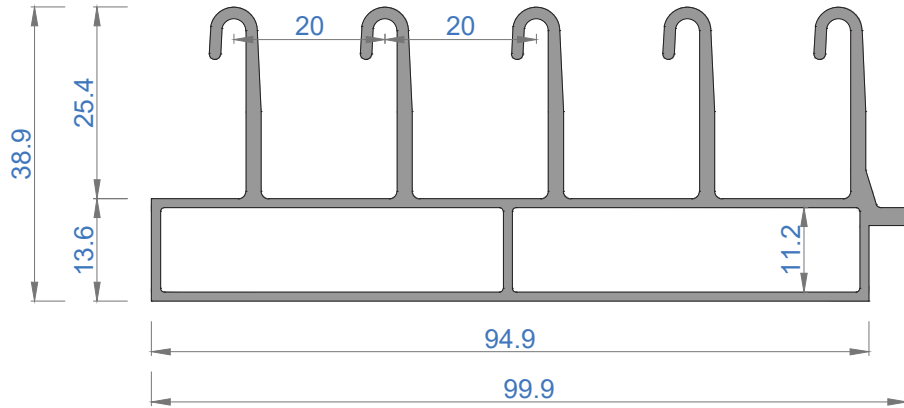

Sistem Kodu 50102

Ağırlık (kg/mt) 1,553

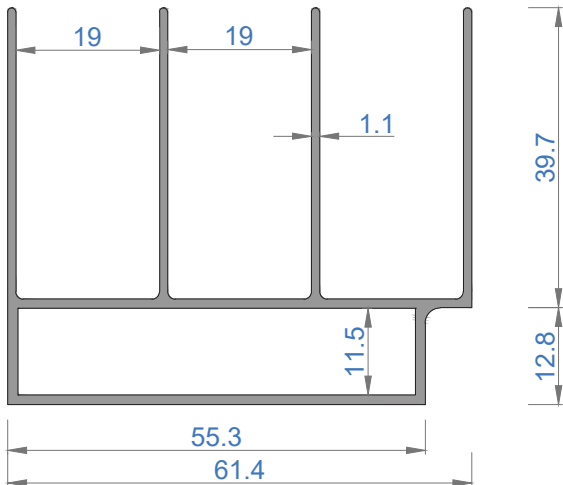

Sistem Kodu 50101

Ağırlık (kg/mt) 0,933

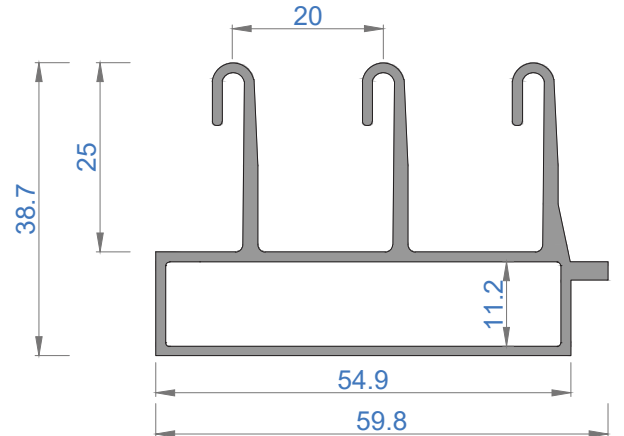

Sistem Kodu 50103

Ağırlık (kg/mt) 0,949

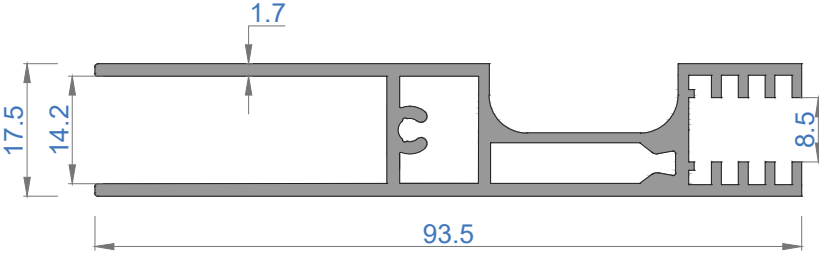

Sistem Kodu **50104**
Ağırlık (kg/mt) **1,158**

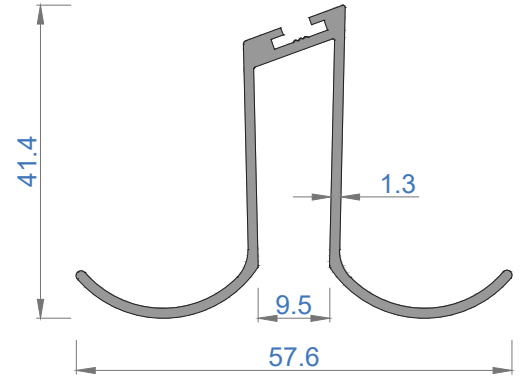

Sistem Kodu **50105**
Ağırlık (kg/mt) **0,494**

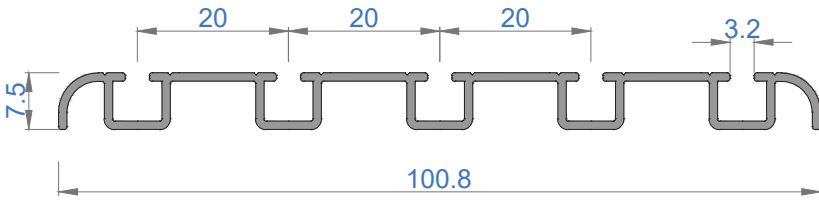

Sistem Kodu **50106**
Ağırlık (kg/mt) **0,552**

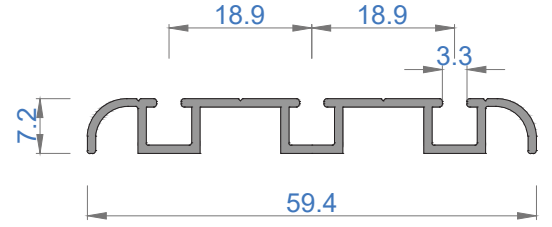

Sistem Kodu **50107**
Ağırlık (kg/mt) **0,333**

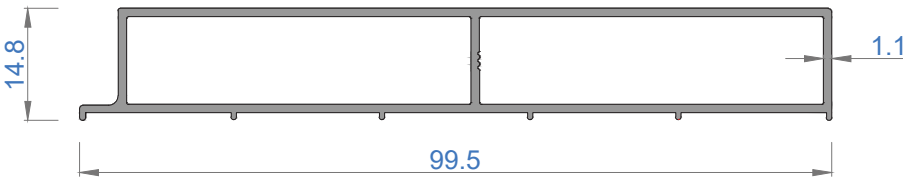

Sistem Kodu **50108**
Ağırlık (kg/mt) **0,691**

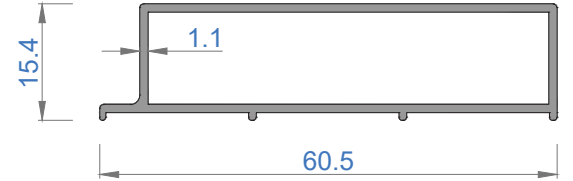

Sistem Kodu **50109**
Ağırlık (kg/mt) **0,428**

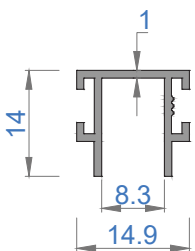

Sistem Kodu **50110**
Ağırlık (kg/mt) **0,138**

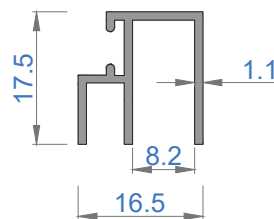

Sistem Kodu **50111**
Ağırlık (kg/mt) **0,185**

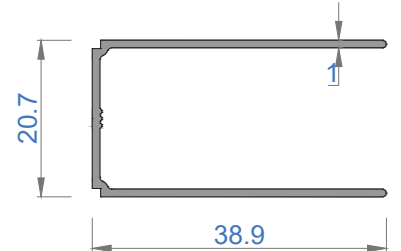

Sistem Kodu **50112**
Ağırlık (kg/mt) **0,261**

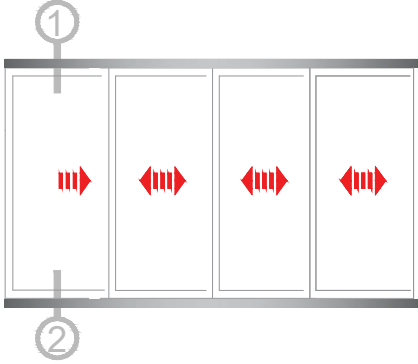

D-1

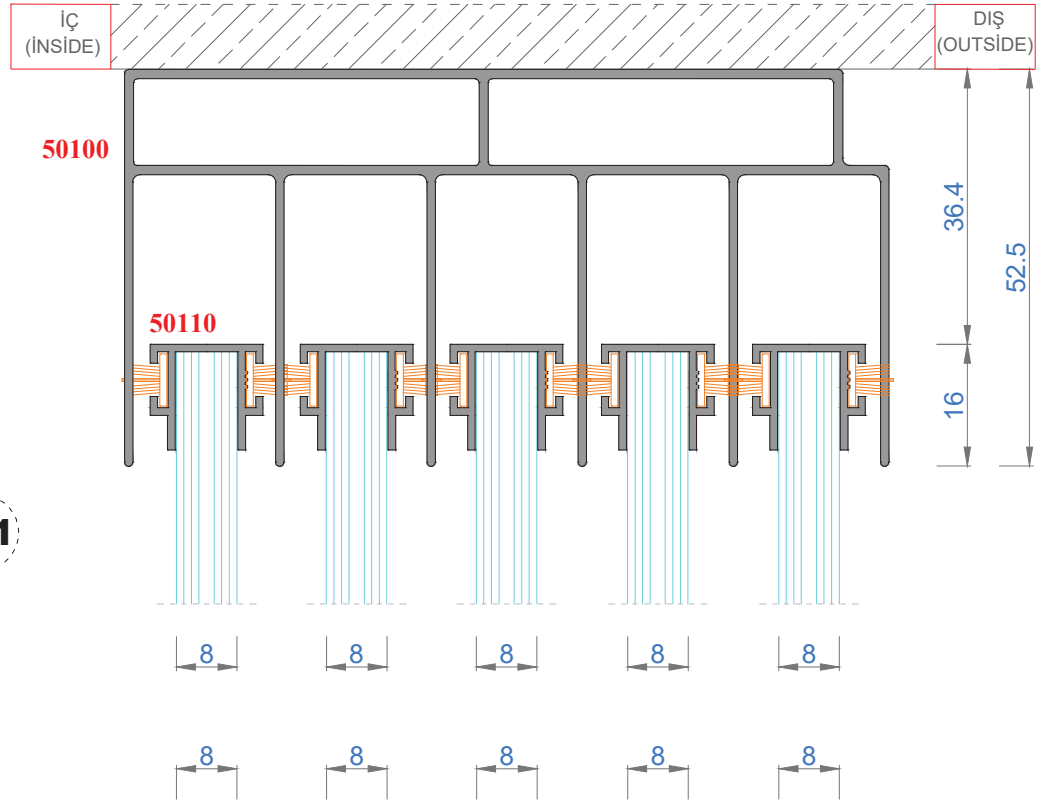

D-2

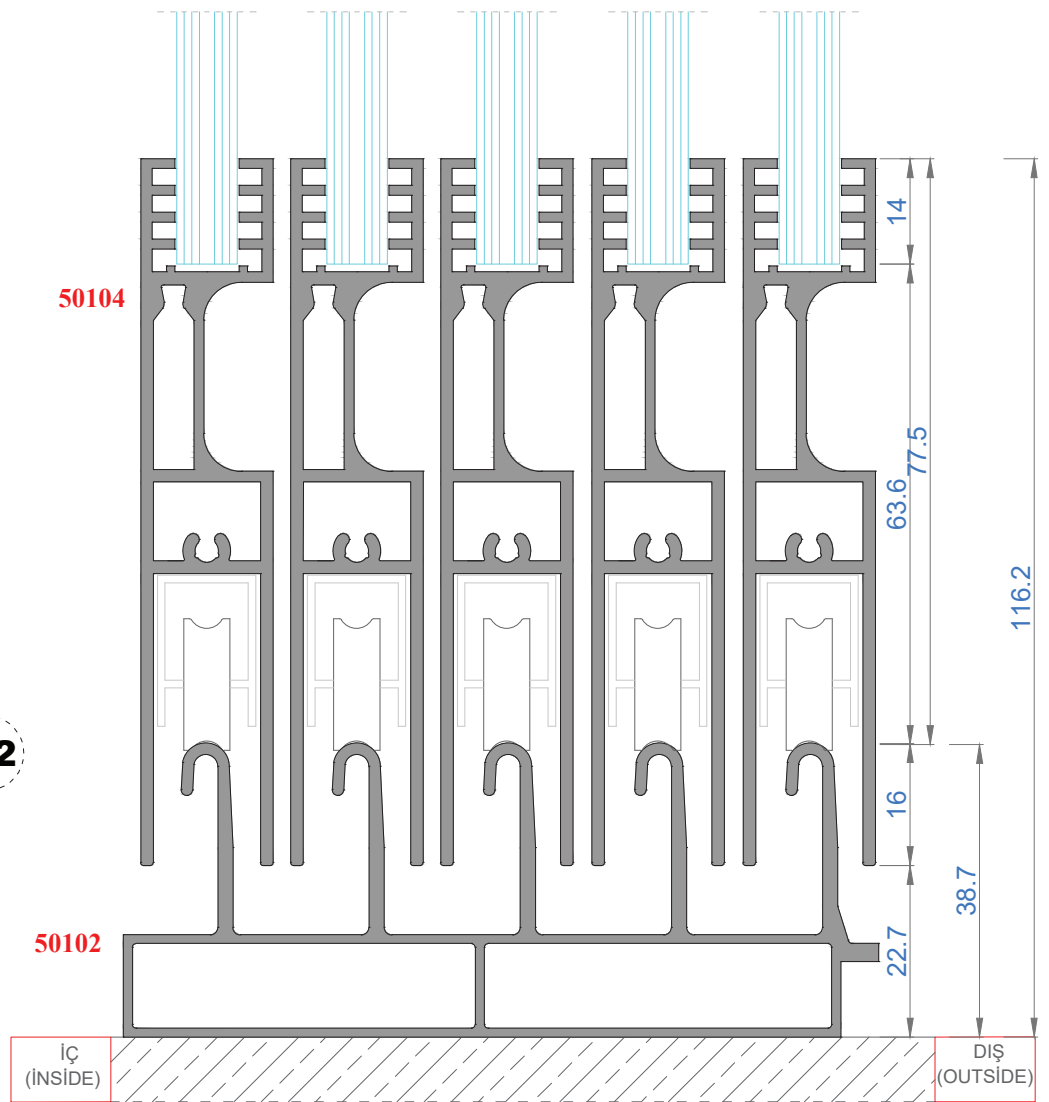

NOT: Profil ağırlıkları teoriktir, üretim sonrası ağırlıklar geçerlidir.

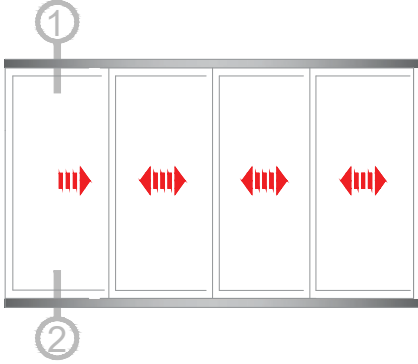

D-1

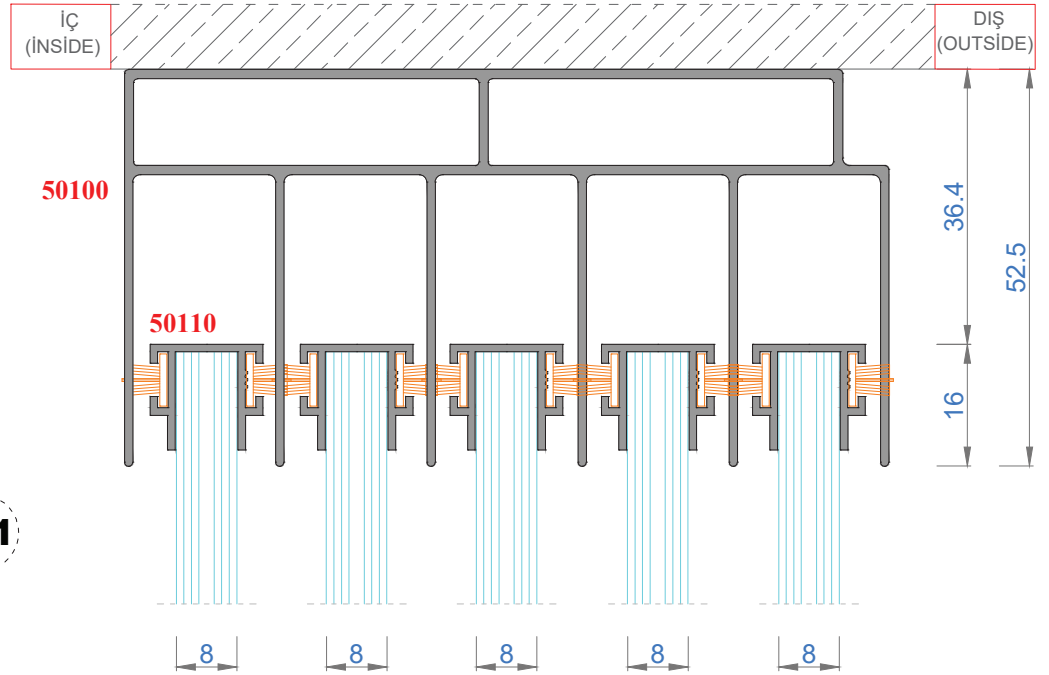

D-2

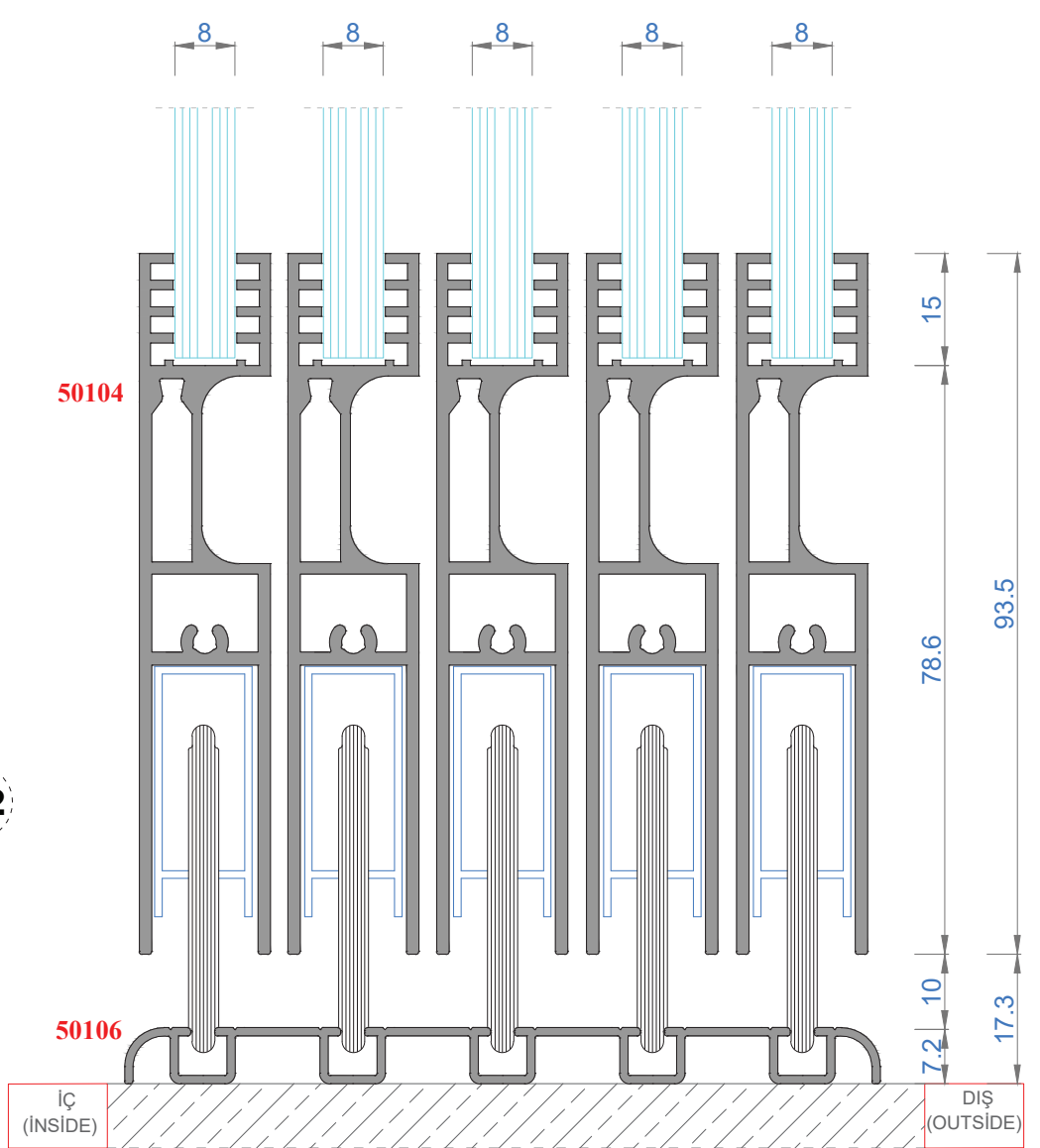

NOT: Profil ağırlıkları teoriktir, üretim sonrası ağırlıklar geçerlidir.

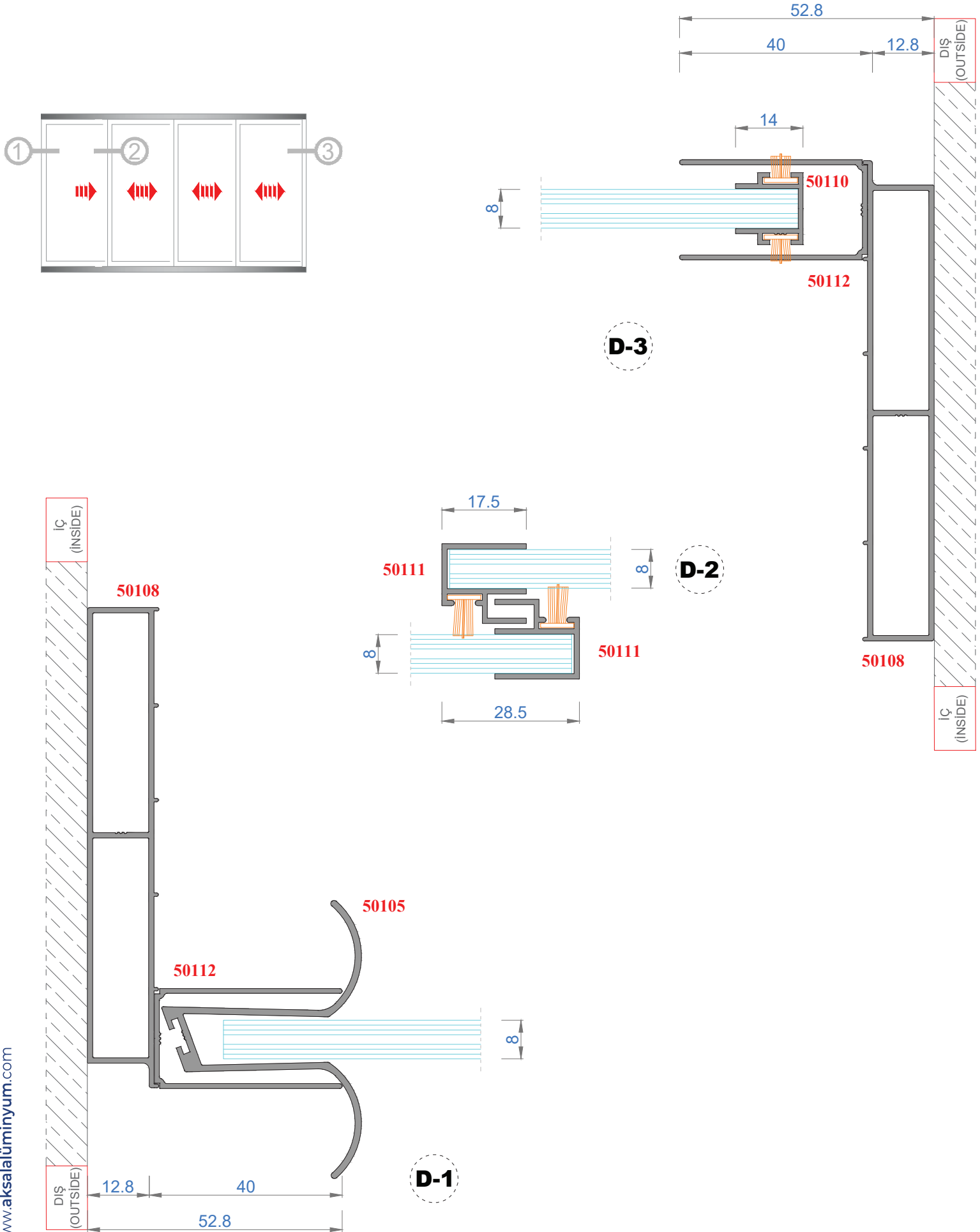

NOT: Profil ağırlıkları teoriktir, üretim sonrası ağırlıklar geçerlidir.

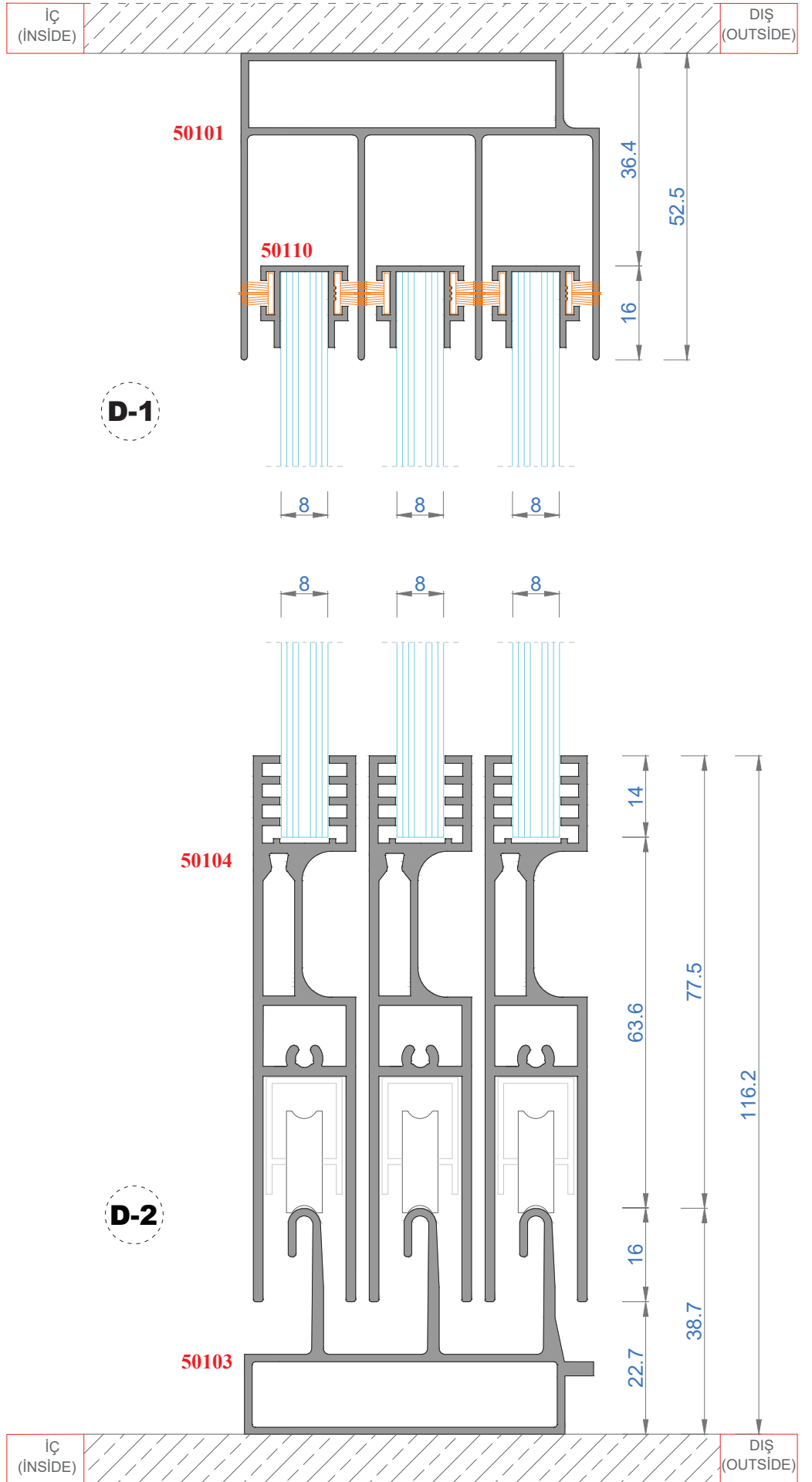
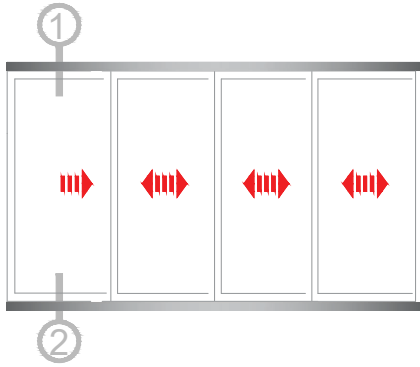

NOT: Profil ağırlıkları teoriktir, üretim sonrası ağırlıklar geçerlidir.

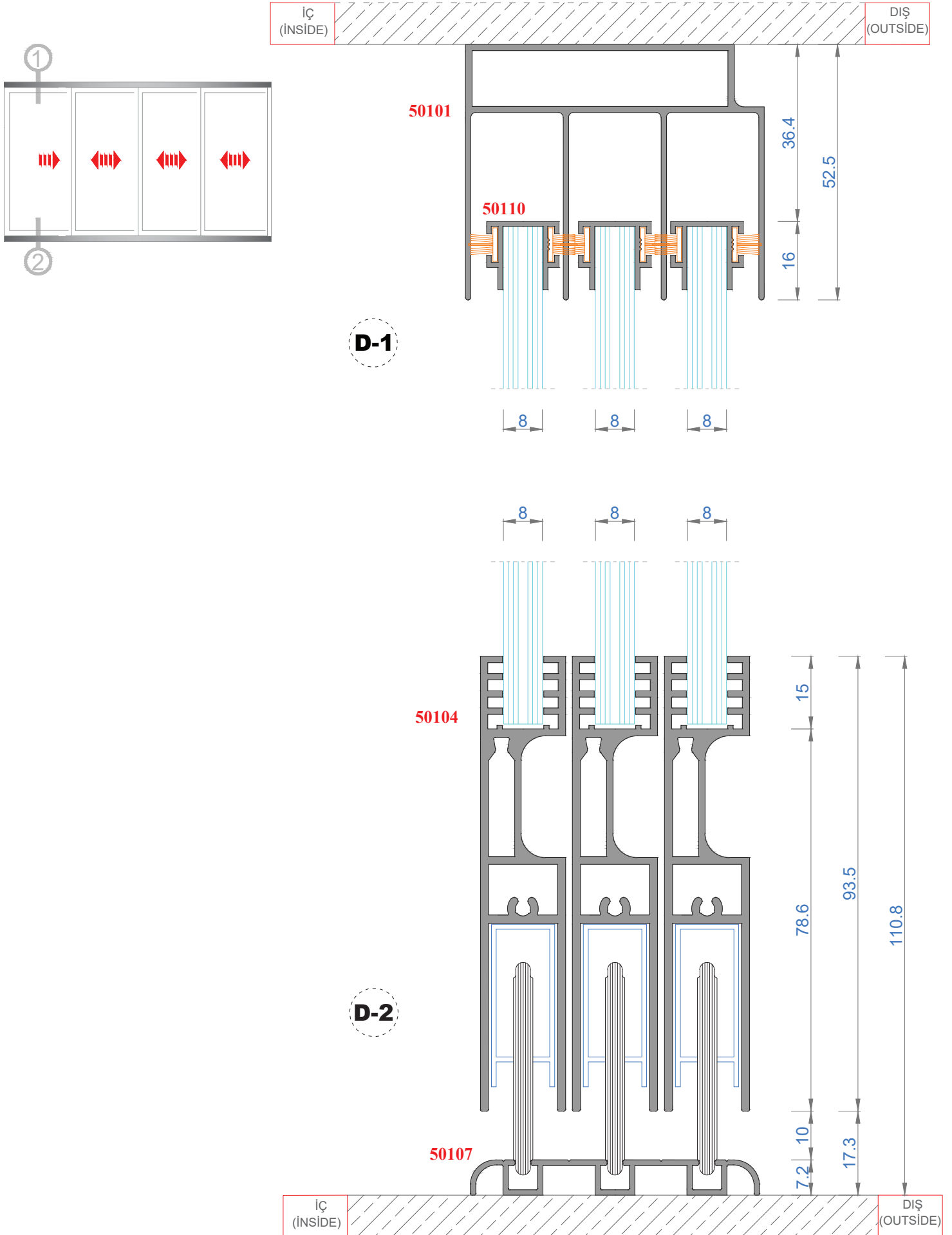

NOT: Profil ağırlıkları teoriktir, üretim sonrası ağırlıklar geçerlidir.

