

MİMARİ SİSTEMLER

32ST YALITIMLI SÜRME SİSTEM SERİSİ
32ST INSULATED SLIDE SYSTEM SERIES

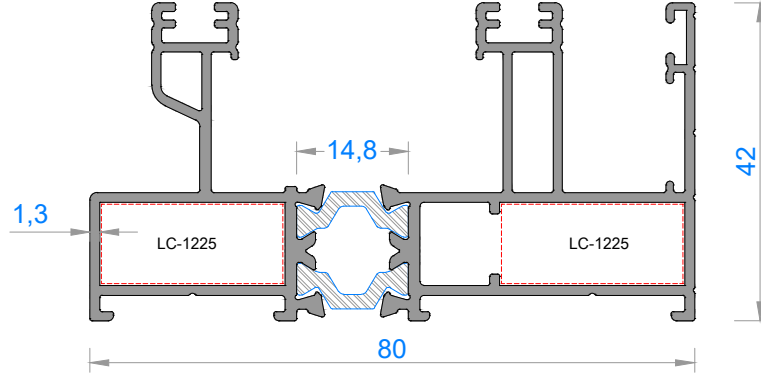

Sistem Kodu	7600-7601	
Ağırlık (kg/mt)	1,485	
Statik Statik	Jx (cm ⁴)	7,98
	Jy (cm ⁴)	32,13

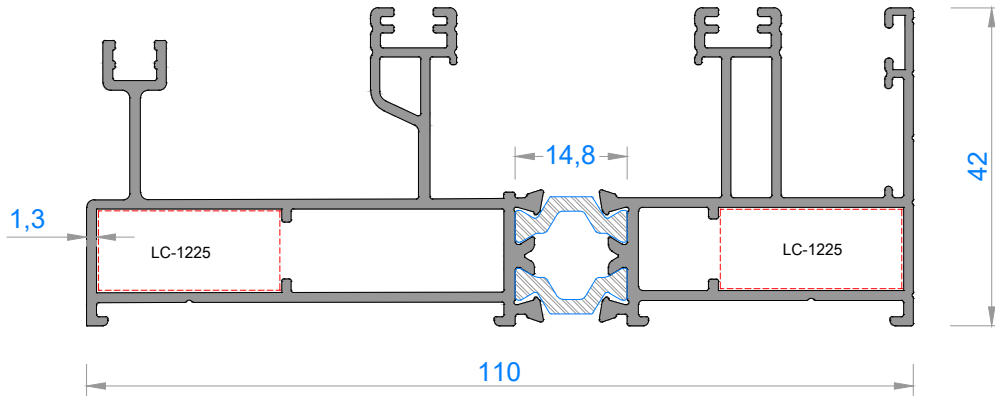

Sistem Kodu	7602-7601	
Ağırlık (kg/mt)	1,824	
Statik Statik	Jx (cm ⁴)	9,60
	Jy (cm ⁴)	72,80

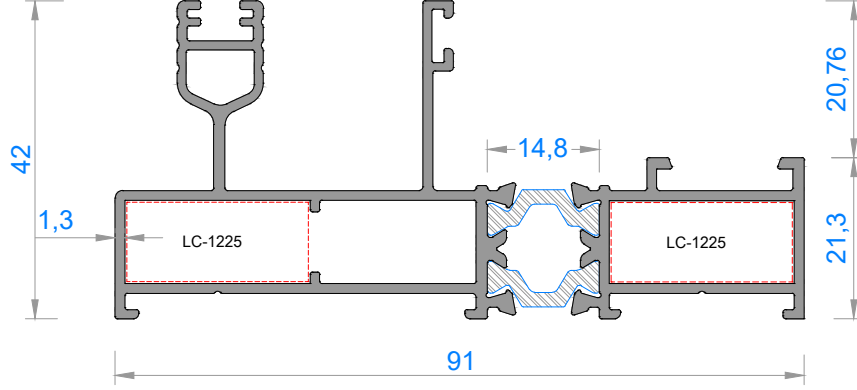

Sistem Kodu 7603-7604

Ağırlık (kg/mt) 1,395

Statik Jx (cm⁴) 5,50

Statik Jy (cm⁴) 36,30

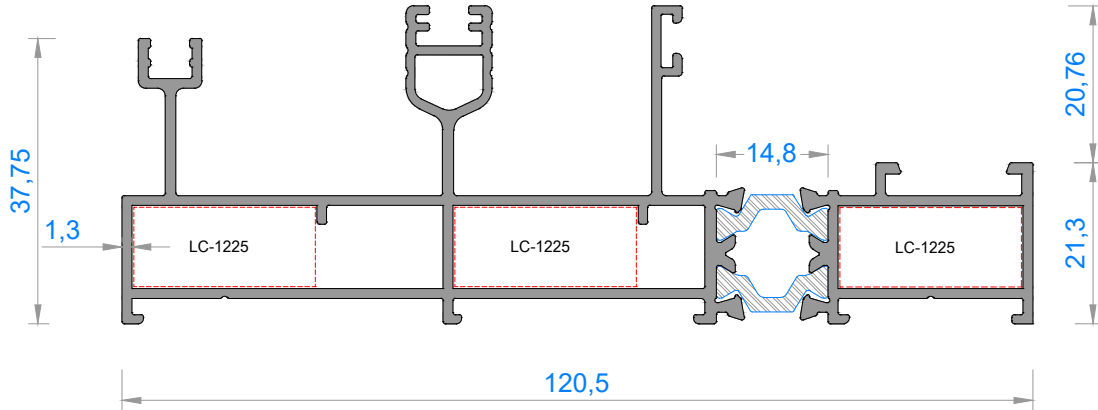

Sistem Kodu 7605-7604

Ağırlık (kg/mt) 1,786

Statik Jx (cm⁴) 7,45

Statik Jy (cm⁴) 78,6

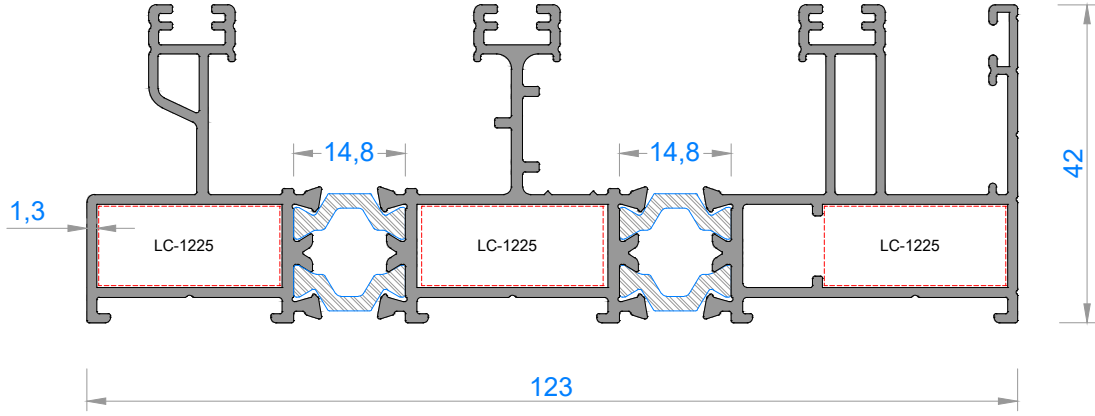

Sistem Kodu **7600-7606-7601**

Ağırlık (kg/mt) 2,262

Statik Jx (cm⁴) 11,68

Statik Jy (cm⁴) 107,25

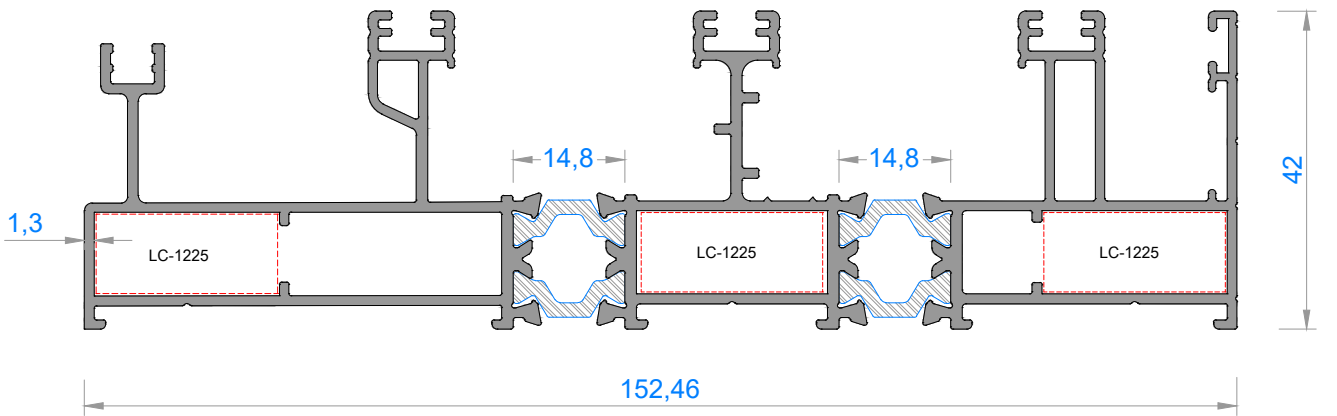

Sistem Kodu **7602-7606-7601**

Ağırlık (kg/mt) 2,601

Statik Jx (cm⁴) 13,28

Statik Jy (cm⁴) 185,05

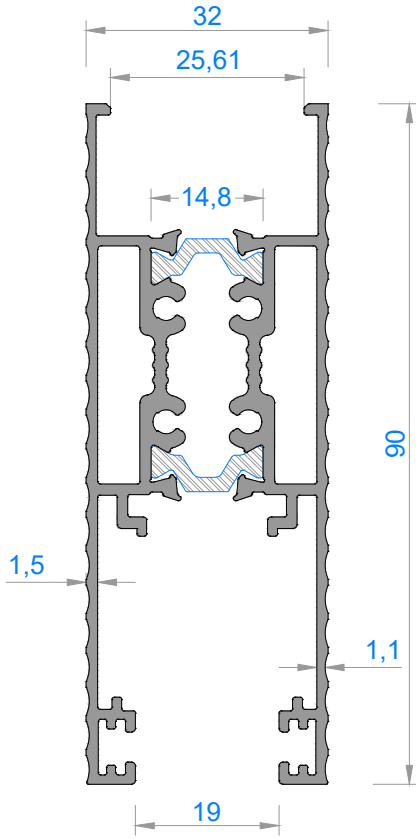

Sistem Kodu	7607-7607
Ağırlık (kg/mt)	1,581
Statik Jx (cm ⁴)	27,82
Statik Jy (cm ⁴)	7,43

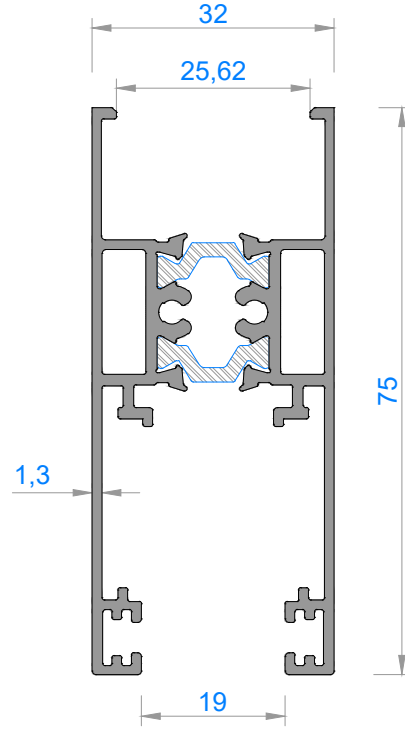

Sistem Kodu	7608-7608
Ağırlık (kg/mt)	1,272
Statik Jx (cm ⁴)	16,10
Statik Jy (cm ⁴)	6,52

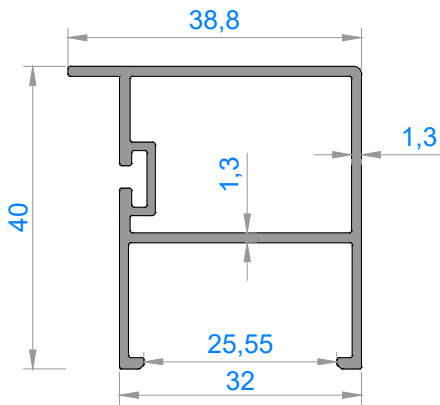

Sistem Kodu	7622
Ağırlık (kg/mt)	0,558
Statik Jx (cm ⁴)	3,66
Statik Jy (cm ⁴)	2,92

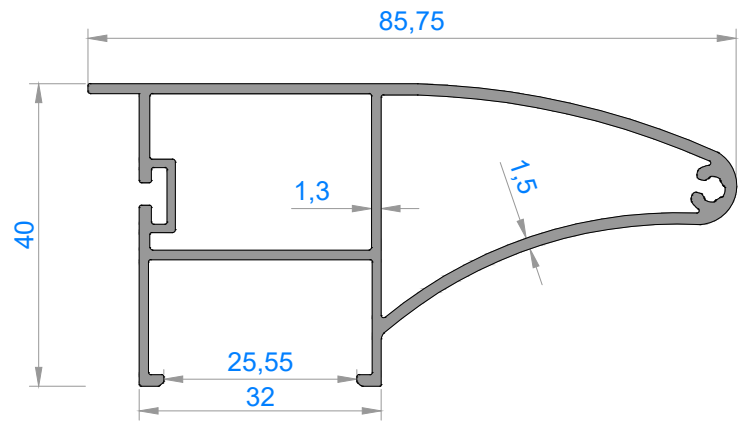

Sistem Kodu	7623
Ağırlık (kg/mt)	1,005
Statik Jx (cm ⁴)	23,83
Statik Jy (cm ⁴)	4,50

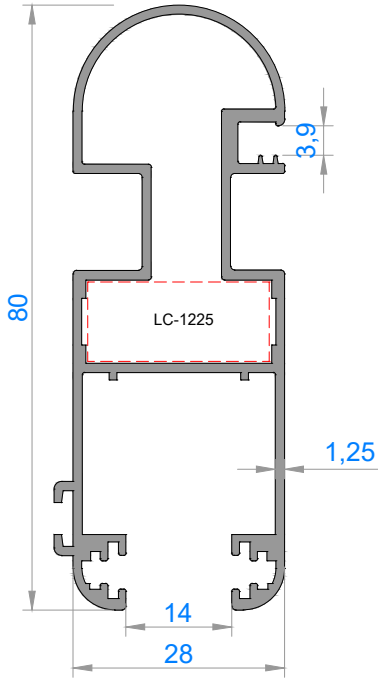

Sistem Kodu	7611
Ağırlık (kg/mt)	0,992
Statik J_x (cm ⁴)	20,40
Statik J_y (cm ⁴)	4,10

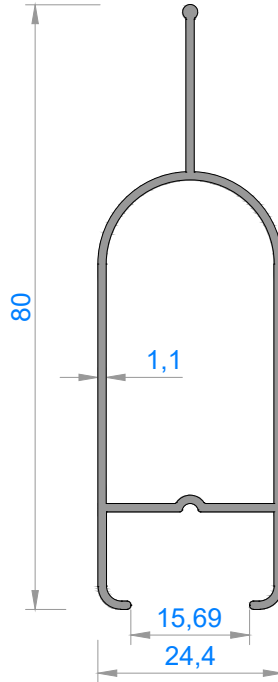

Sistem Kodu	7612*
Ağırlık (kg/mt)	0,532
Statik J_x (cm ⁴)	9,38
Statik J_y (cm ⁴)	1,77

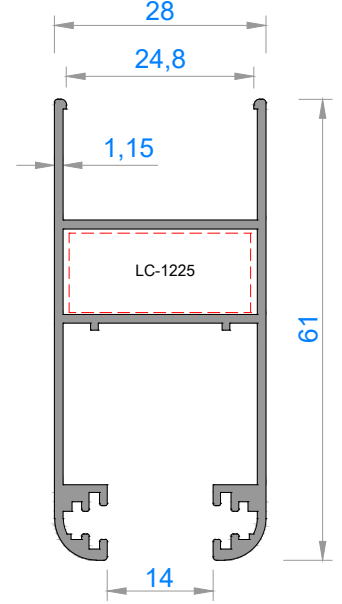

Sistem Kodu	4906
Ağırlık (kg/mt)	0,679
Statik J_x (cm ⁴)	7,80
Statik J_y (cm ⁴)	3,33

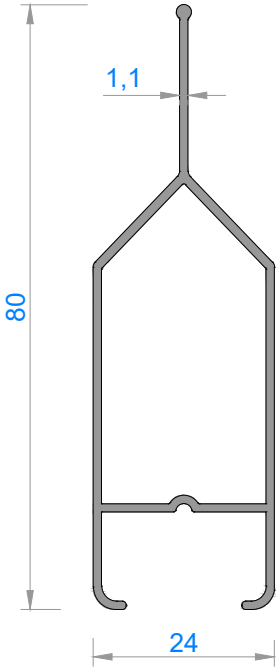

Sistem Kodu	7613
Ağırlık (kg/mt)	0,528
Statik J_x (cm ⁴)	9,07
Statik J_y (cm ⁴)	1,16

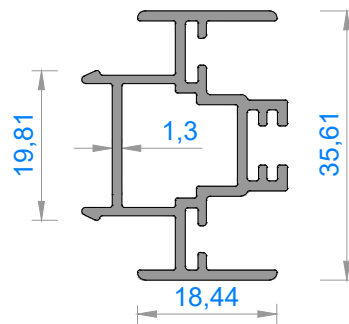

Sistem Kodu	7614
Ağırlık (kg/mt)	0,529
Statik J_x (cm ⁴)	2,35
Statik J_y (cm ⁴)	0,96

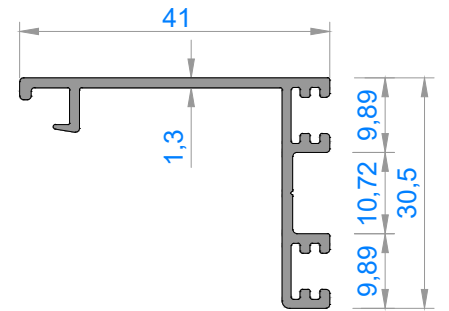

Sistem Kodu	7615
Ağırlık (kg/mt)	0,363
Statik J_x (cm ⁴)	2,84
Statik J_y (cm ⁴)	0,75

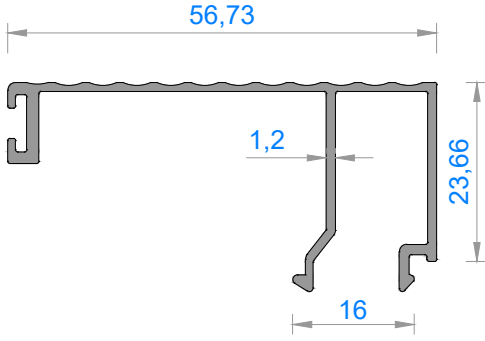

Sistem Kodu	7616
Ağırlık (kg/mt)	0,414
Statik <i>Static</i> Jx (cm ⁴)	0,92
Jy (cm ⁴)	6,30

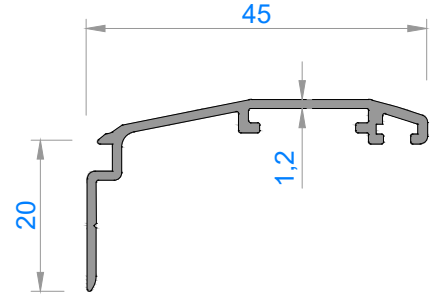

Sistem Kodu	7617
Ağırlık (kg/mt)	0,273
Statik <i>Static</i> Jx (cm ⁴)	2,58
Jy (cm ⁴)	0,21

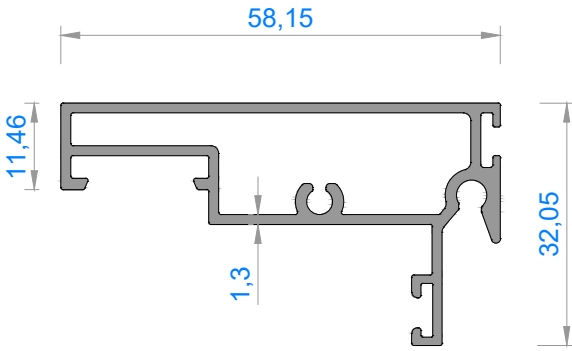

Sistem Kodu	7618
Ağırlık (kg/mt)	0,709
Statik <i>Static</i> Jx (cm ⁴)	9,23
Jy (cm ⁴)	1,40

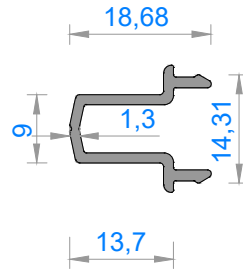

Sistem Kodu	4915
Ağırlık (kg/mt)	0,176

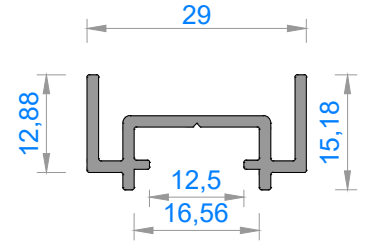

Sistem Kodu	7619
Ağırlık (kg/mt)	0,289

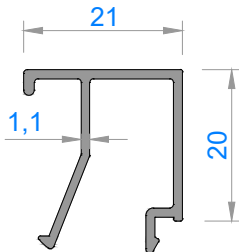

Sistem Kodu	7620
Ağırlık (kg/mt)	0,238

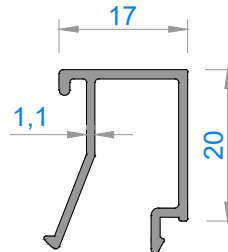

Sistem Kodu	7621*
Ağırlık (kg/mt)	0,225

ALYAN KÖŞE BİRLEŞTİRME - IMPORTED CORNER JOINT

LC - 1125

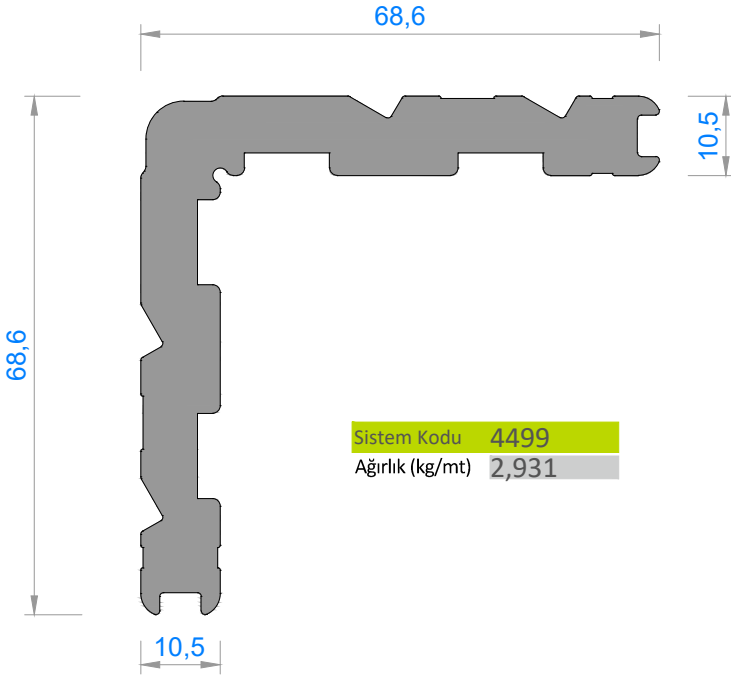
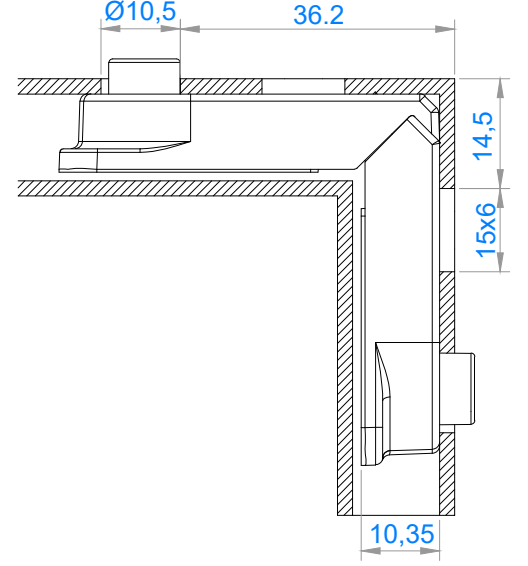
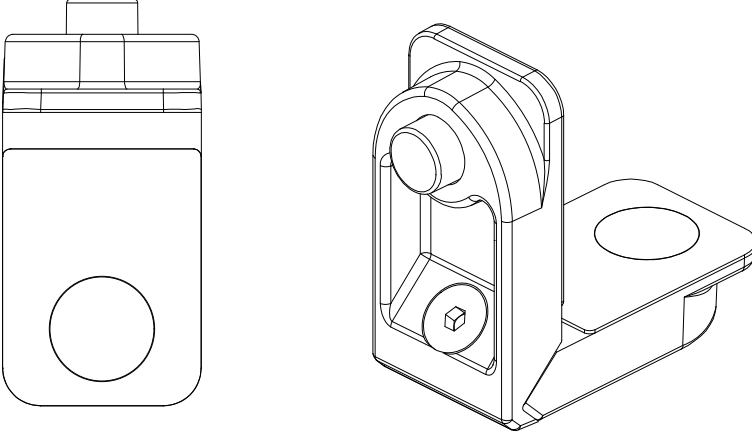

KÖŞE TAKOZLARI (CORNER JOINT)			
Nr	 L m	AKS. KODU ACS. CODE	KESİM ÖLÇÜSÜ CUTTING SIZE
7600-7601	4499	4499 - 24	24 mm
	4499	4499 - 24	24 mm
7602-7601	4499	4499 - 24	24 mm
	4499	4499 - 24	24 mm
7603-7604	4499	4499 - 24	24 mm
	4499	4499 - 24	24 mm
7605-7604	4499	4499 - 24	24 mm
	4499	4499 - 24	24 mm
	4499	4499 - 24	24 mm
7600-7606-7601	4499	4499 - 24	24 mm
	4499	4499 - 24	24 mm
	4499	4499 - 24	24 mm
7602-7606-7601	4499	4499 - 24	24 mm
	4499	4499 - 24	24 mm
	4499	4499 - 24	24 mm

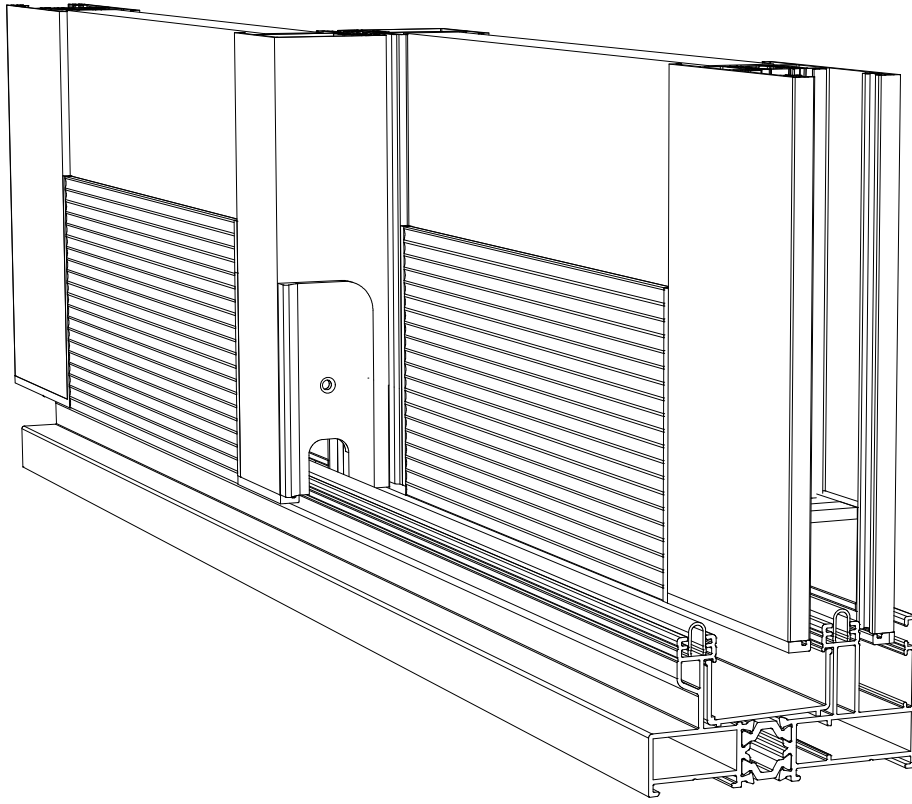

MİMARİ SİSTEMLER

32ST SİSTEM DETAYLARI

32ST SYSTEM DETAILS

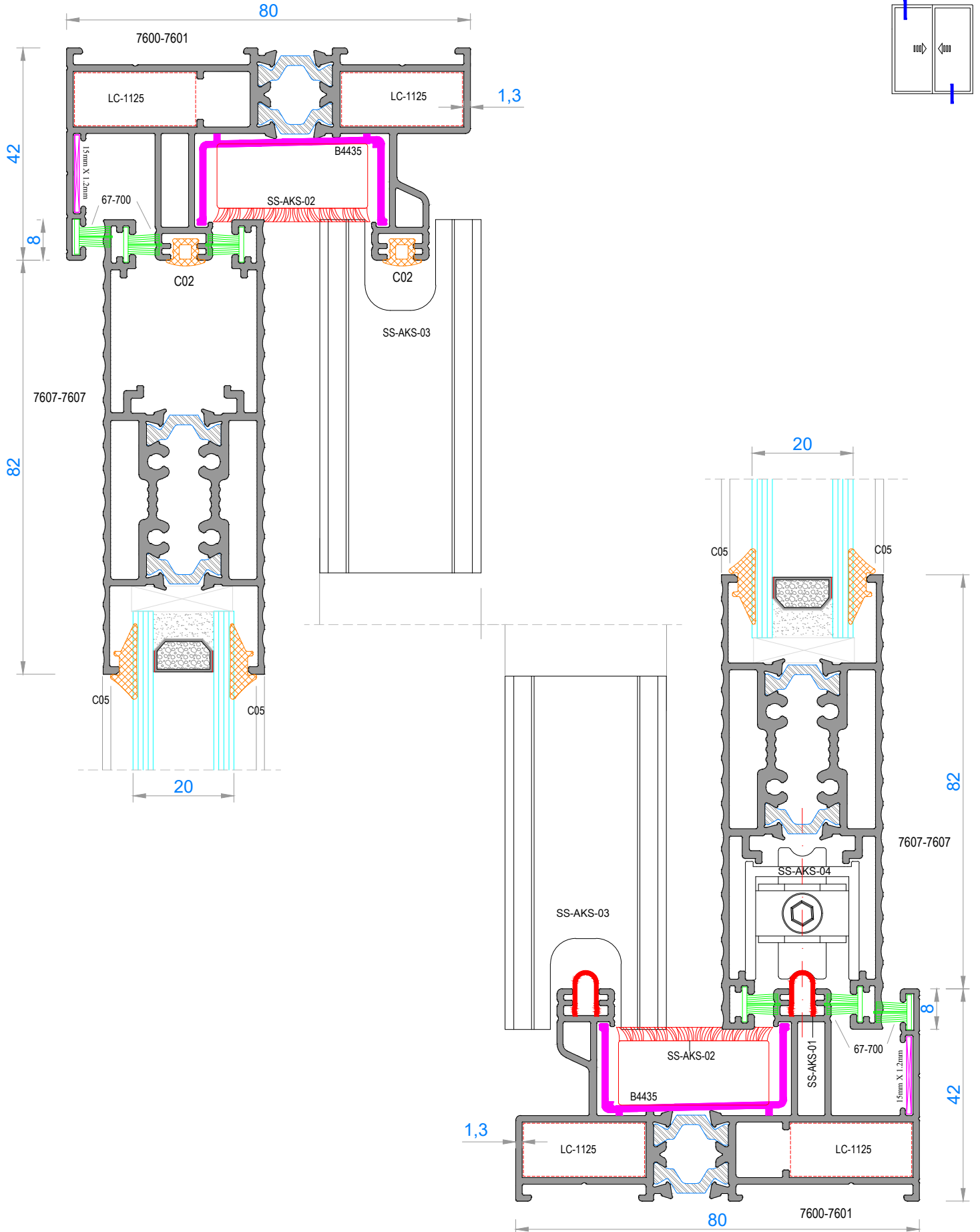

NOT: Profil ağırlıkları teoriktir, üretim sonrası ağırlıklar geçerlidir.

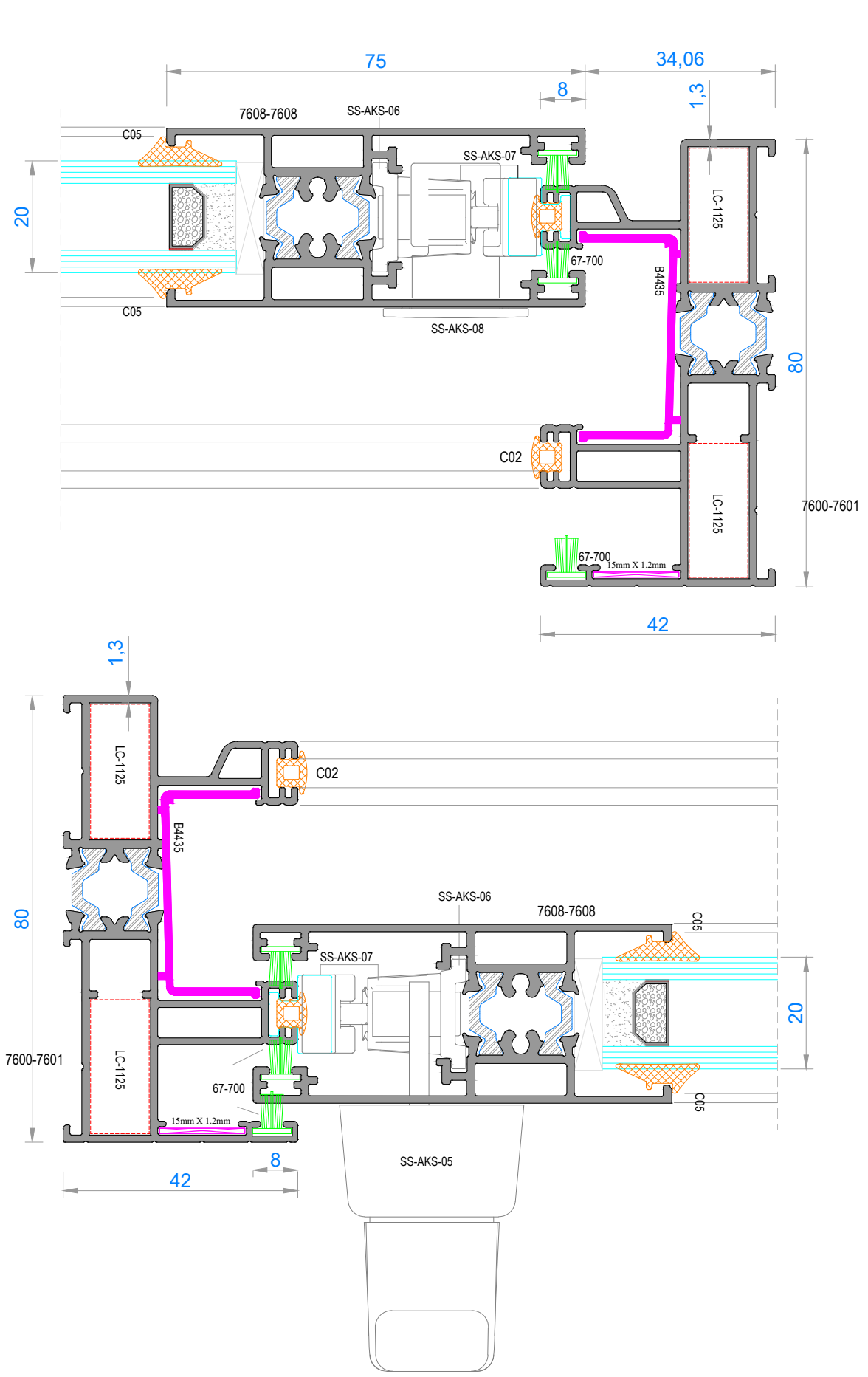

NOT: Profil ağırlıkları teoriktir, üretim sonrası ağırlıklar geçerlidir.

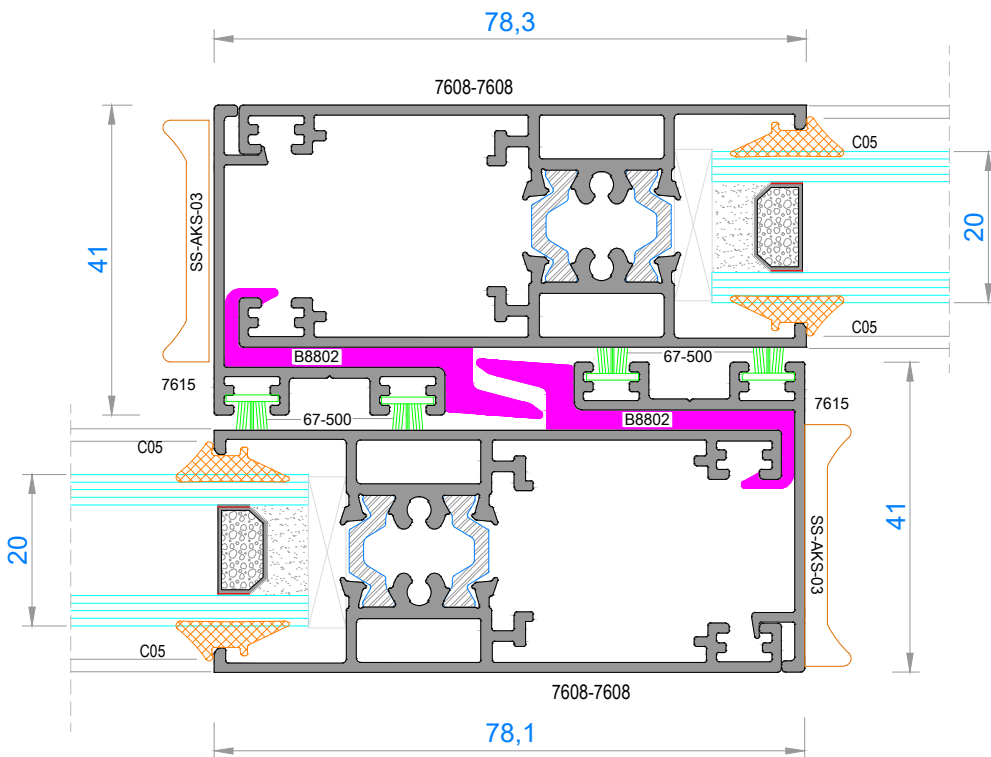
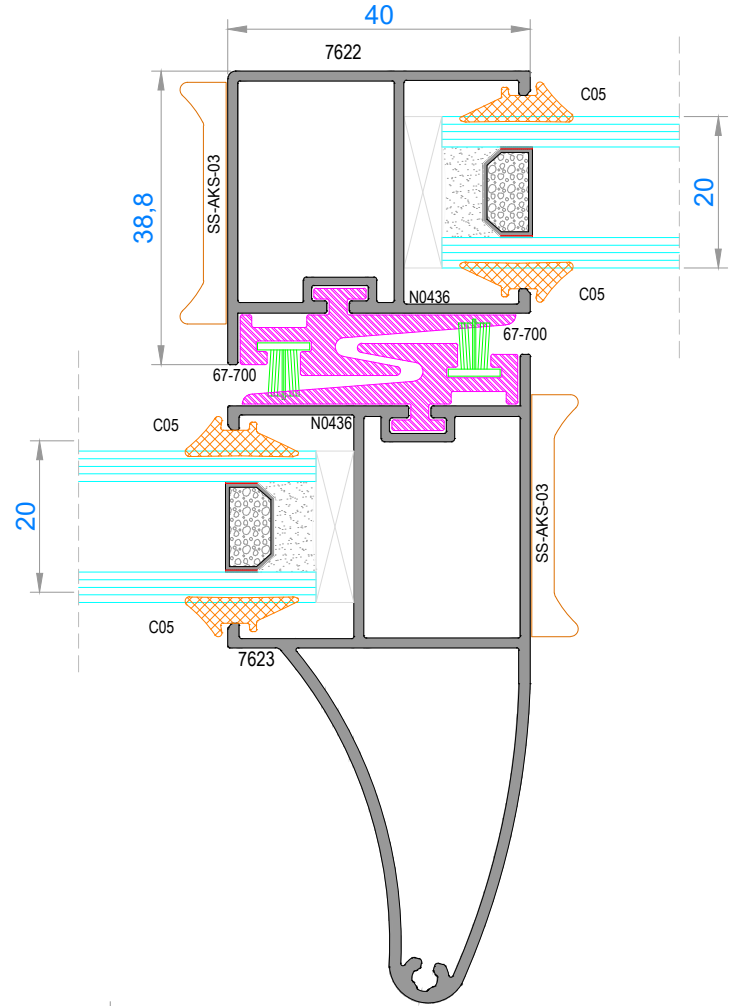
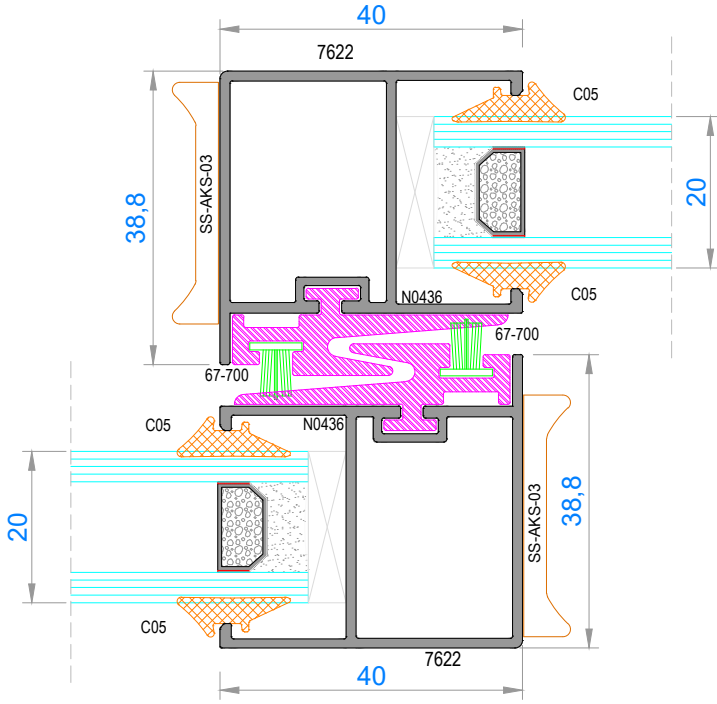
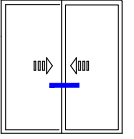

NOT: Profil ağırlıkları teoriktir, üretim sonrası ağırlıklar geçerlidir.

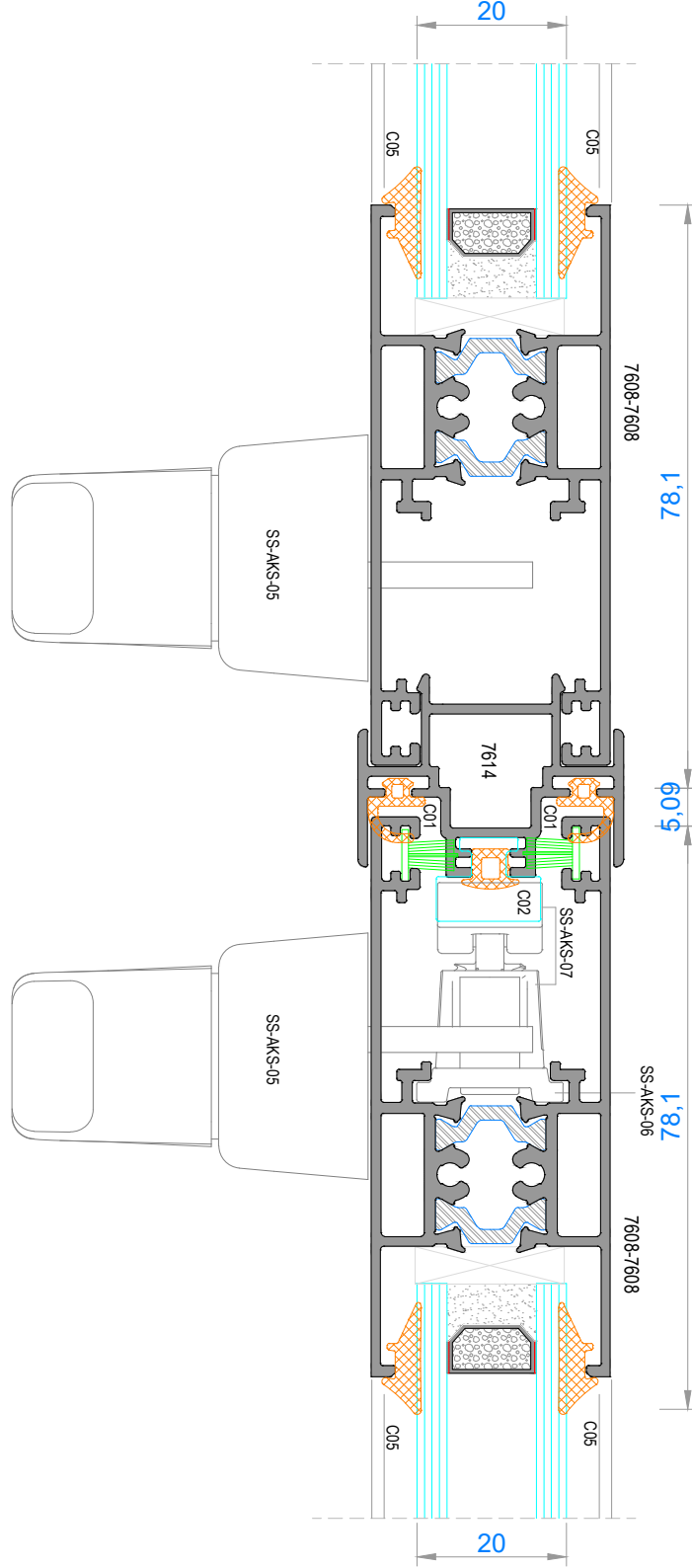
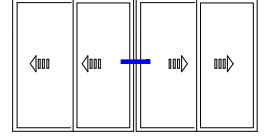

NOT: Profil ağırlıkları teoriktir, üretim sonrası ağırlıklar geçerlidir.

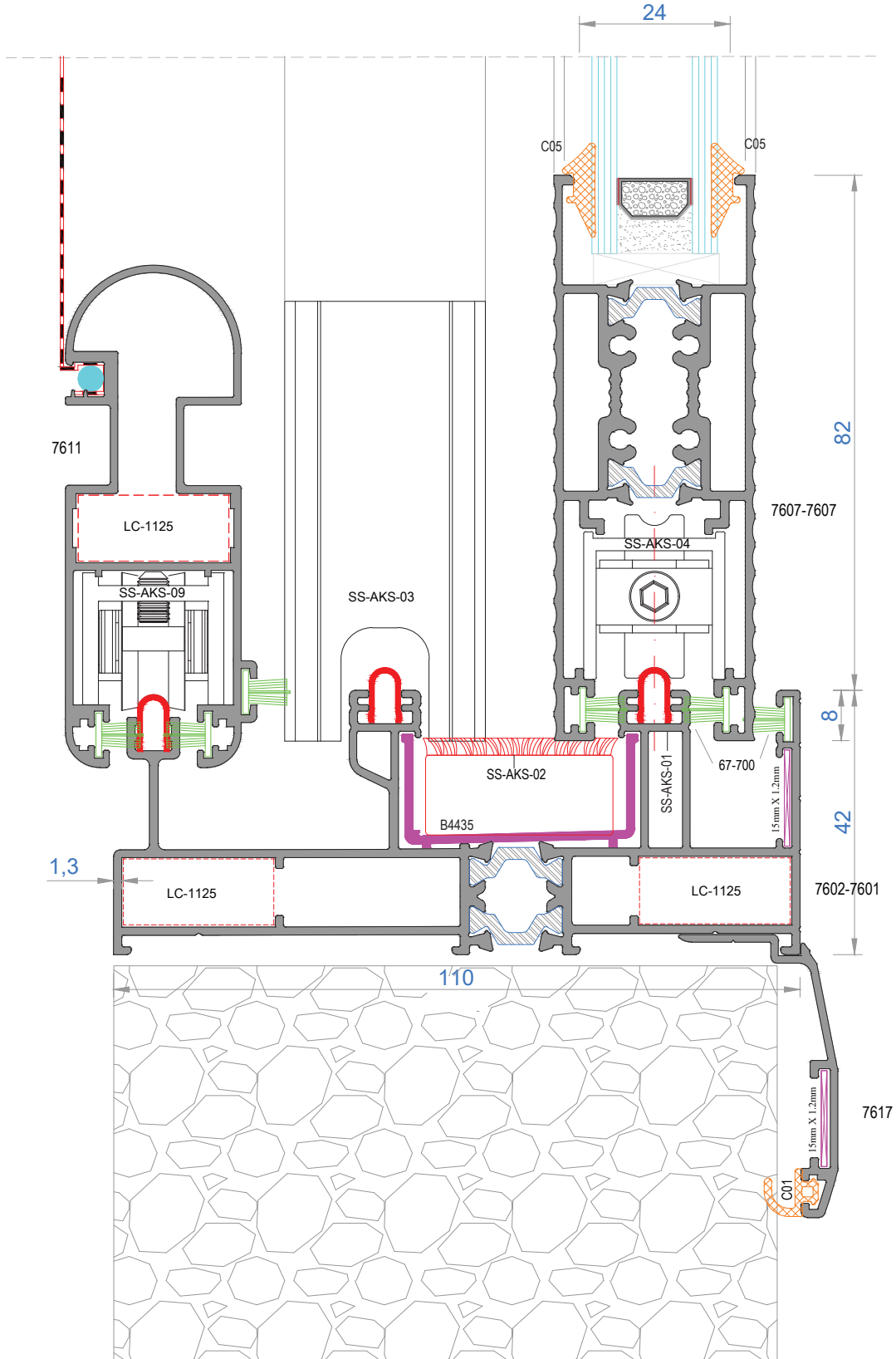
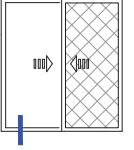

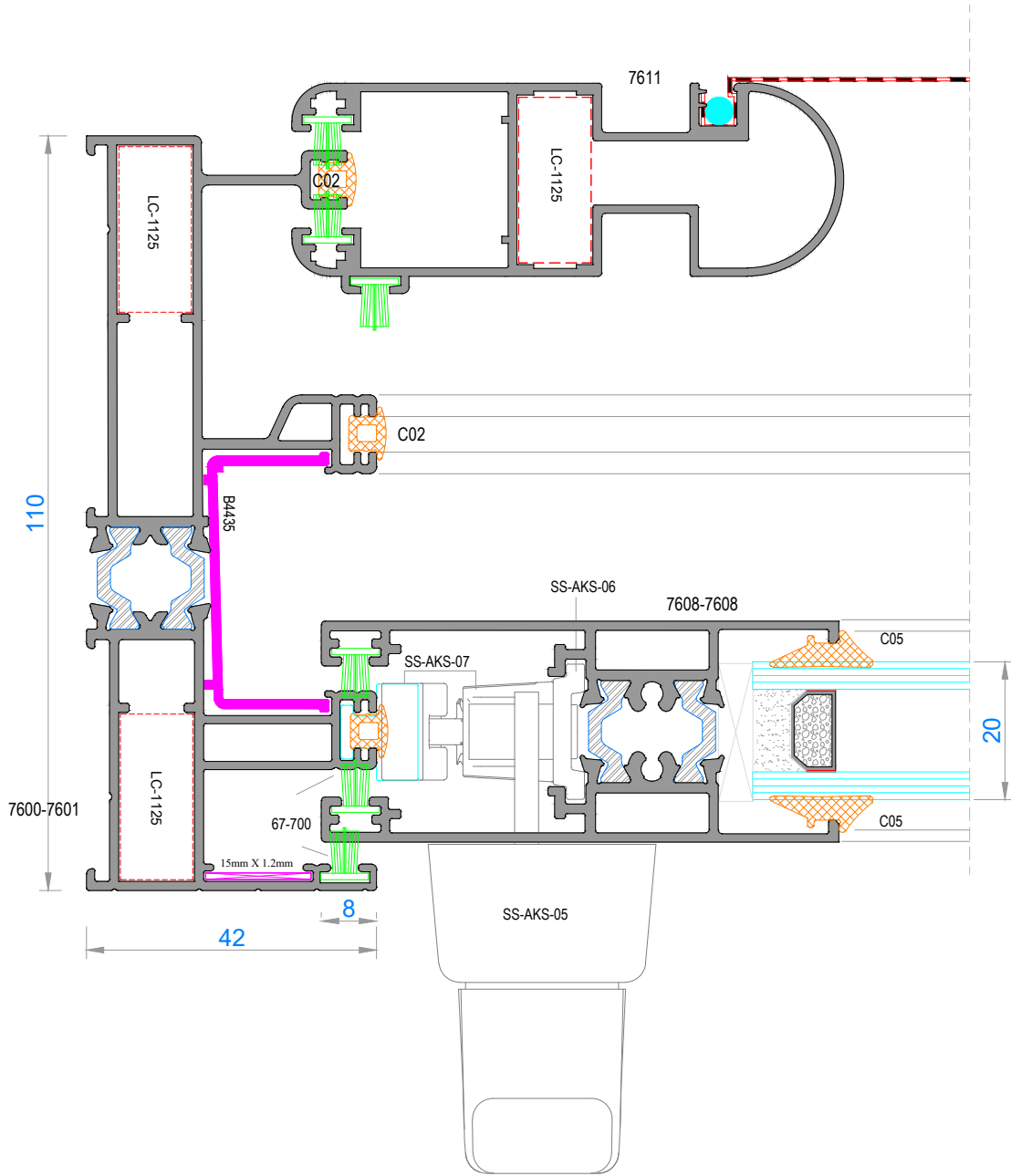
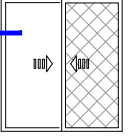

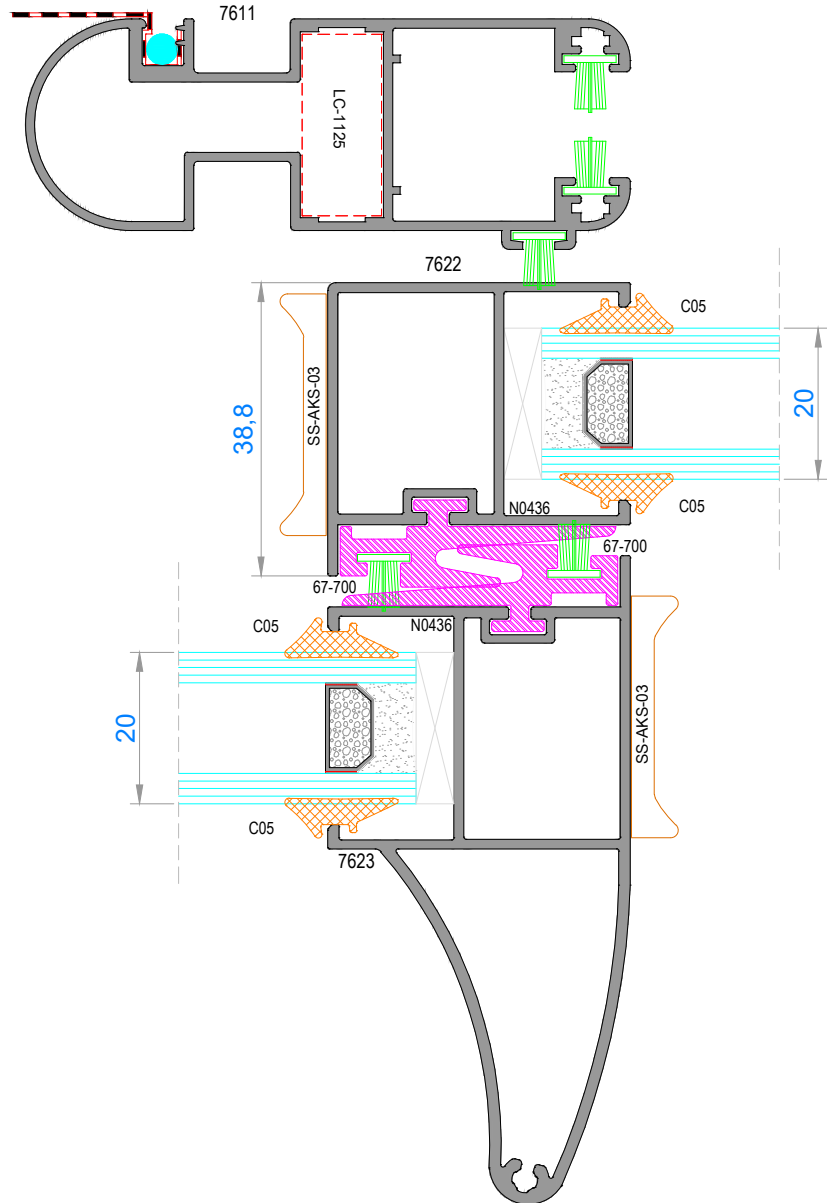
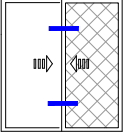
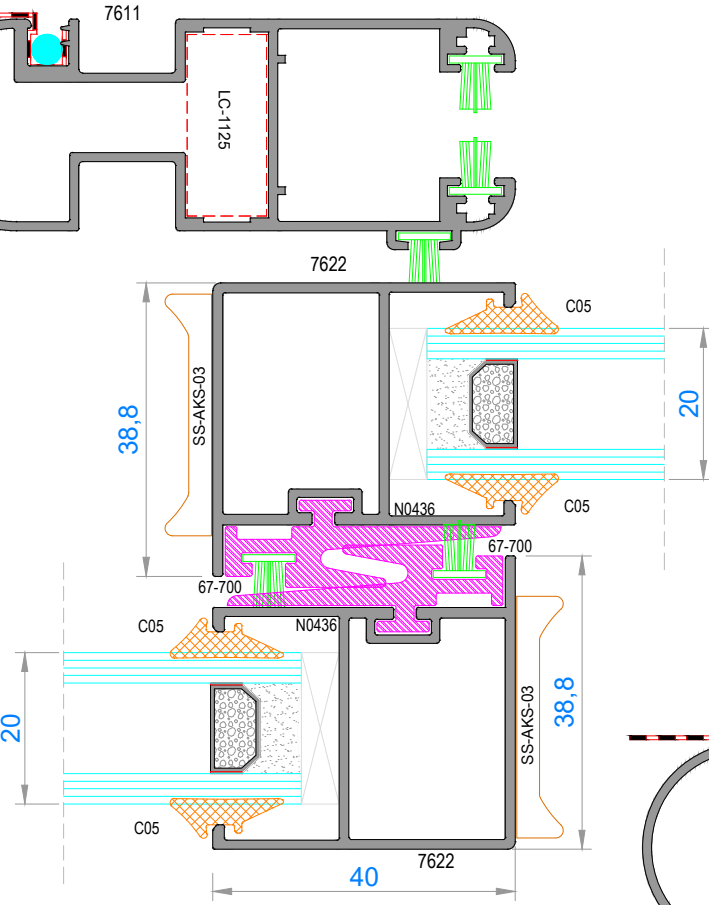

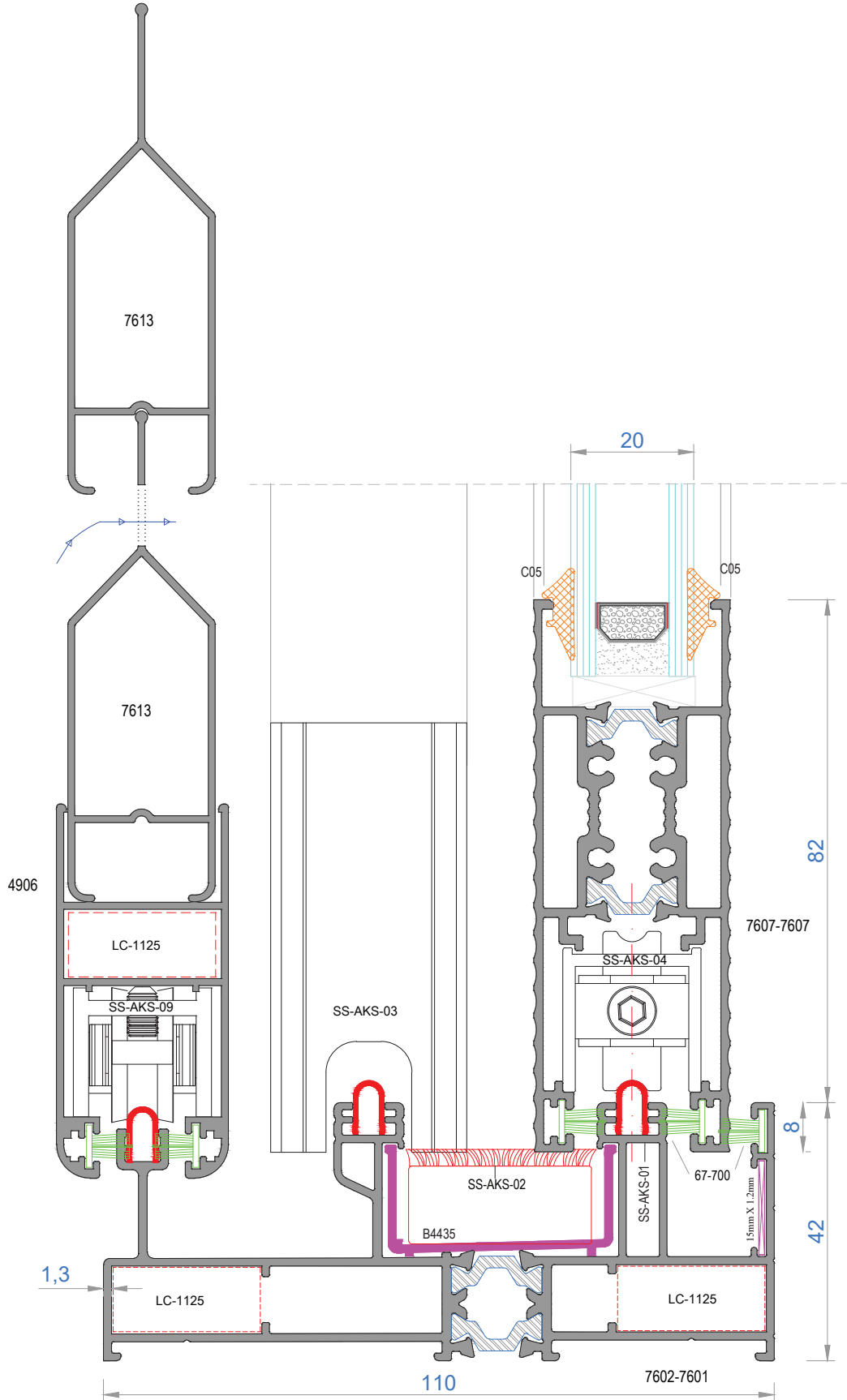
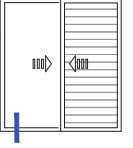

NOT: Prof l ağırlıkları teor kt r, üret m sonrası ağırlıklar gerl d r.

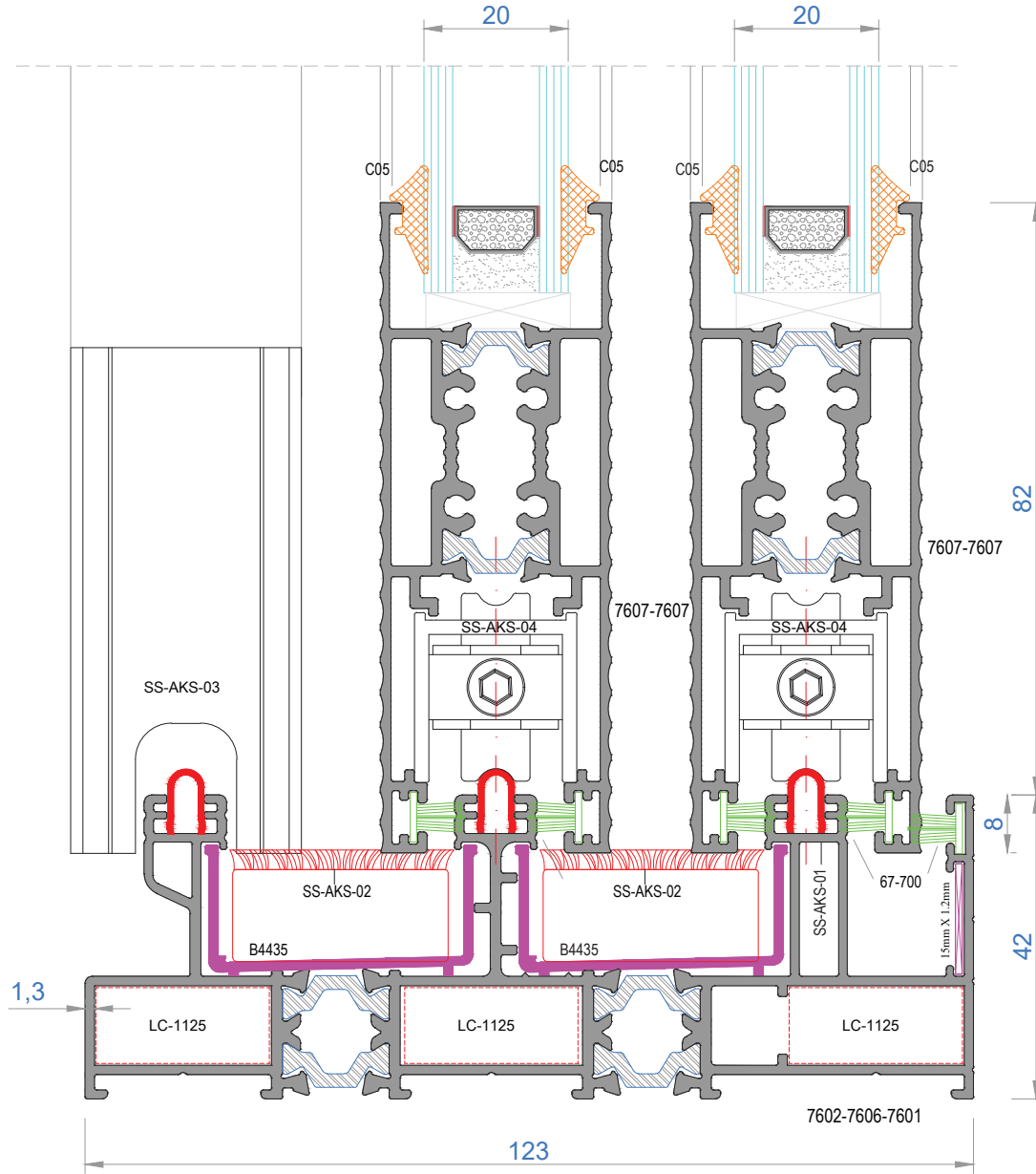
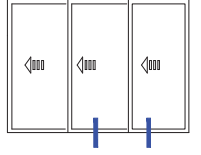

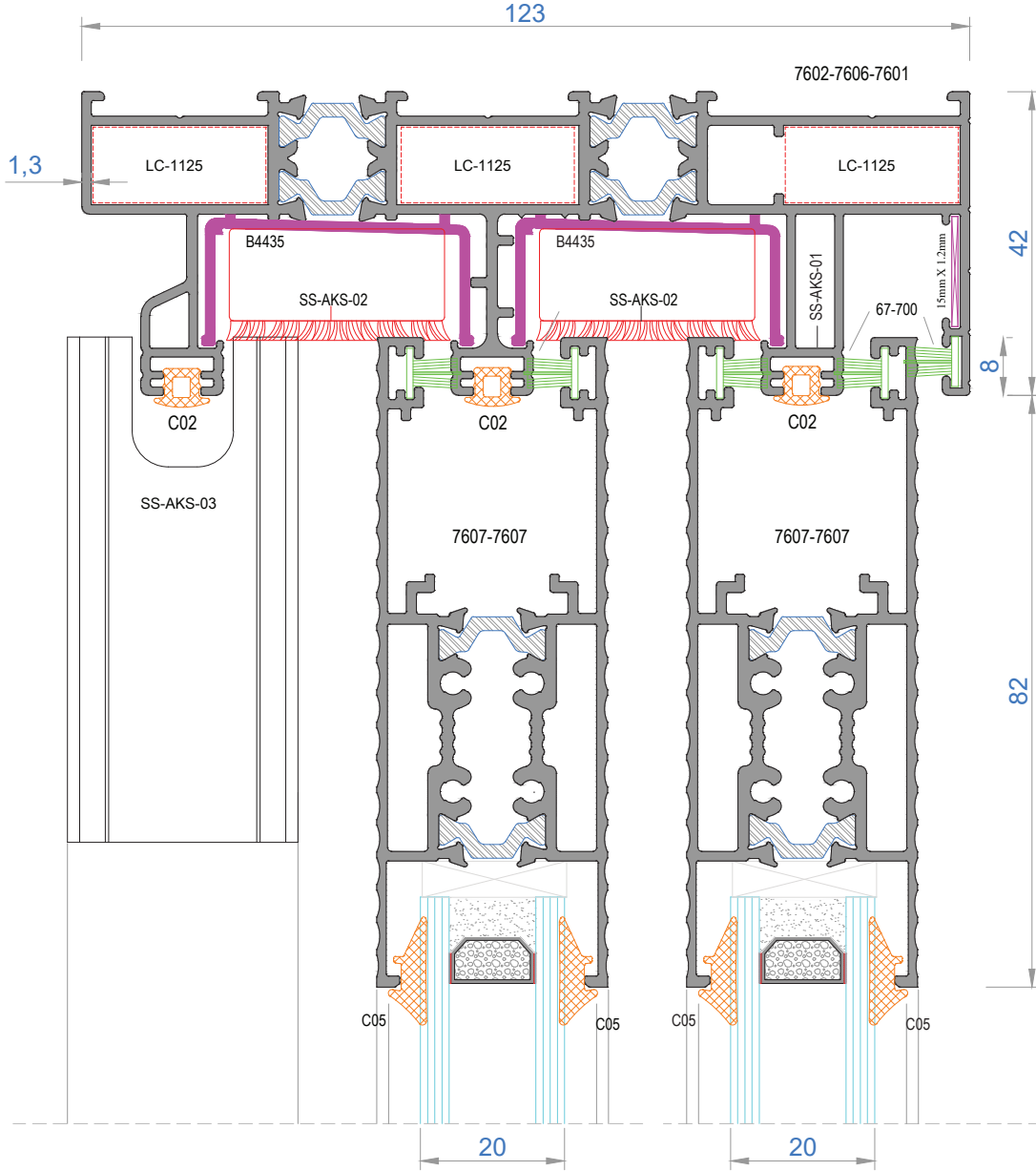
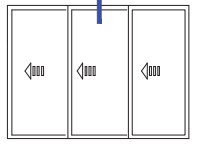

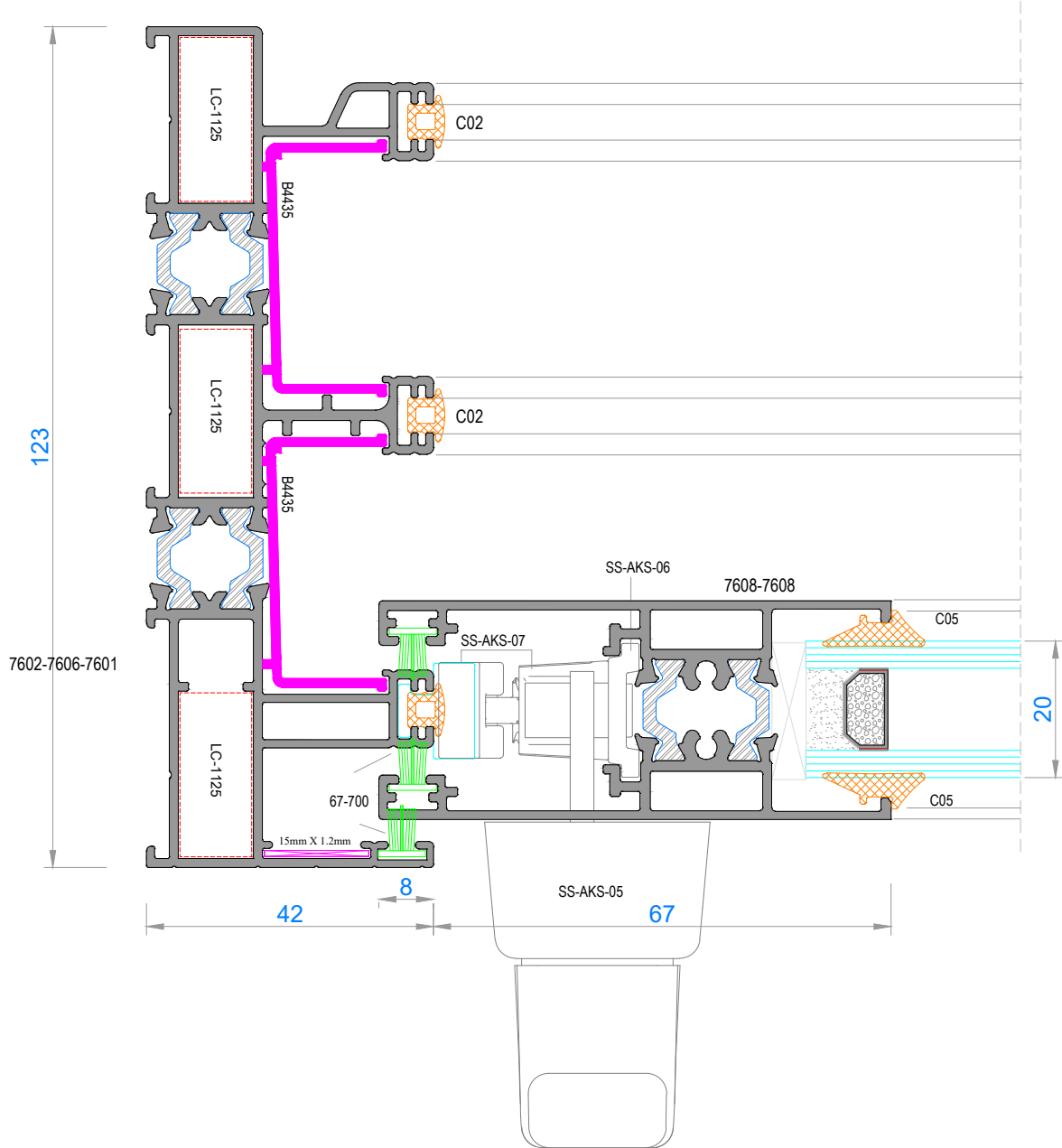
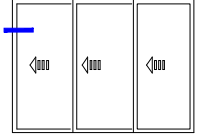

NOT: Profil ağırlıkları teoriktir, üretim sonrası ağırlıklar geçerlidir.

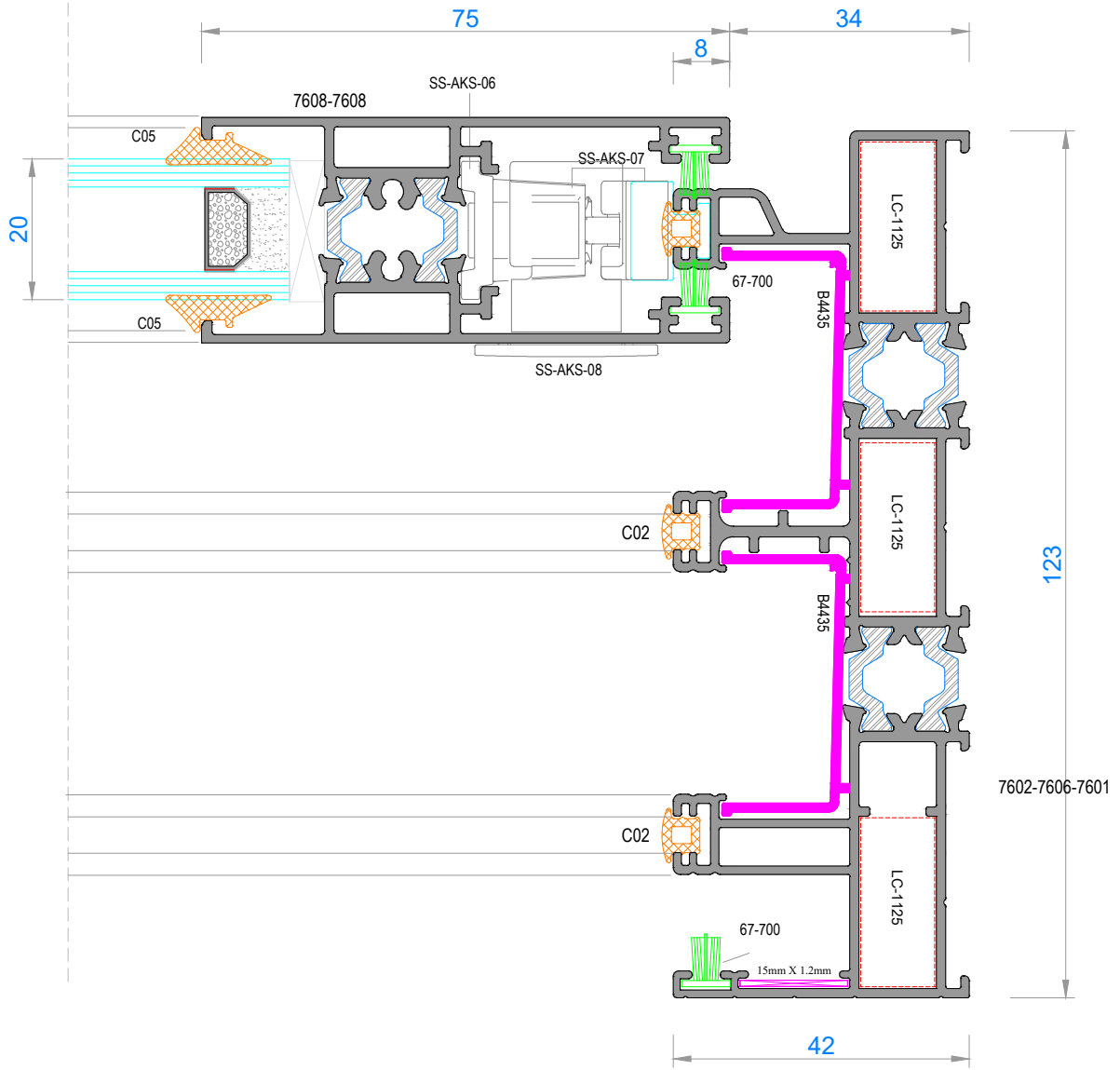
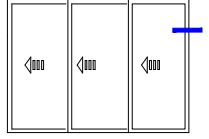

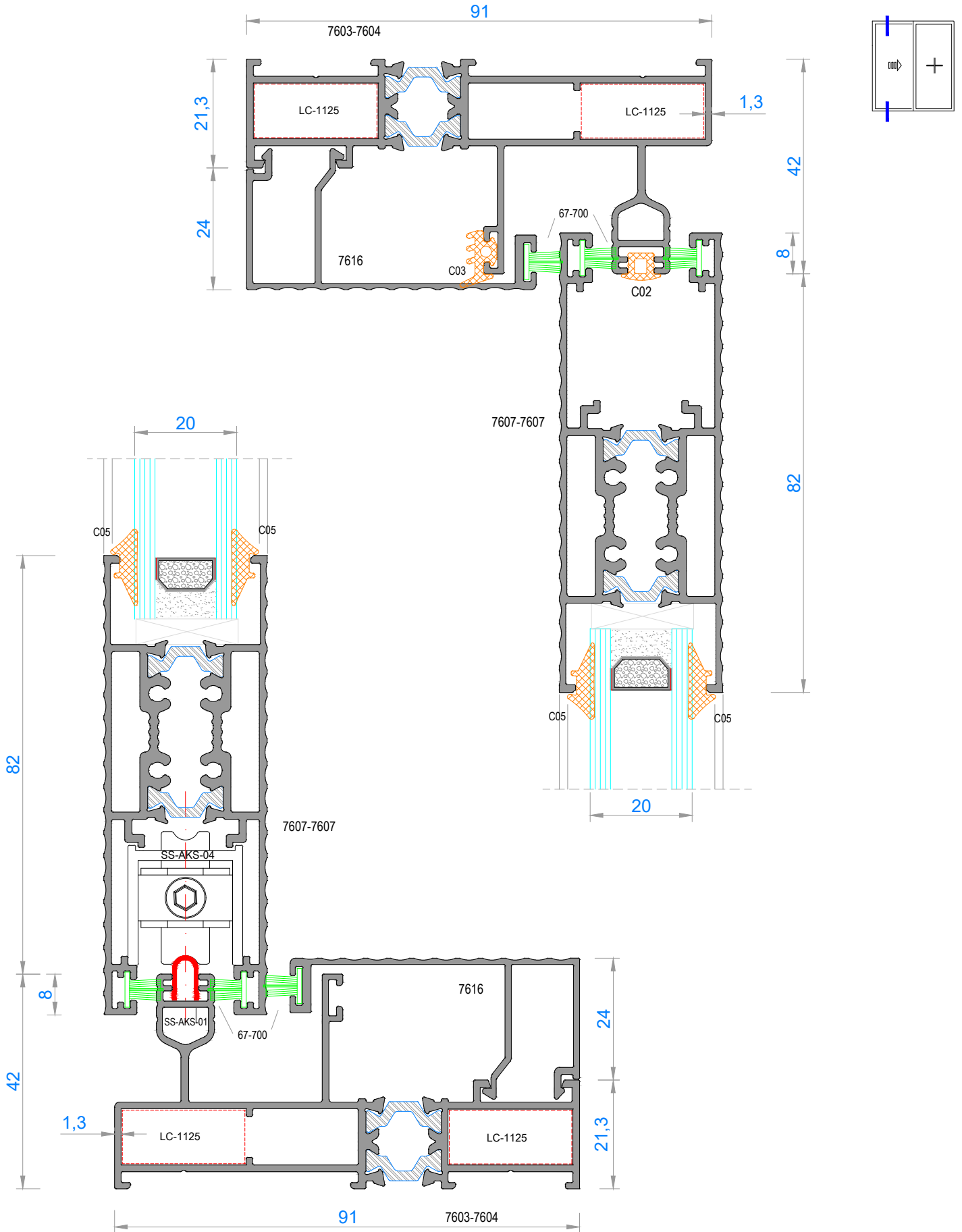

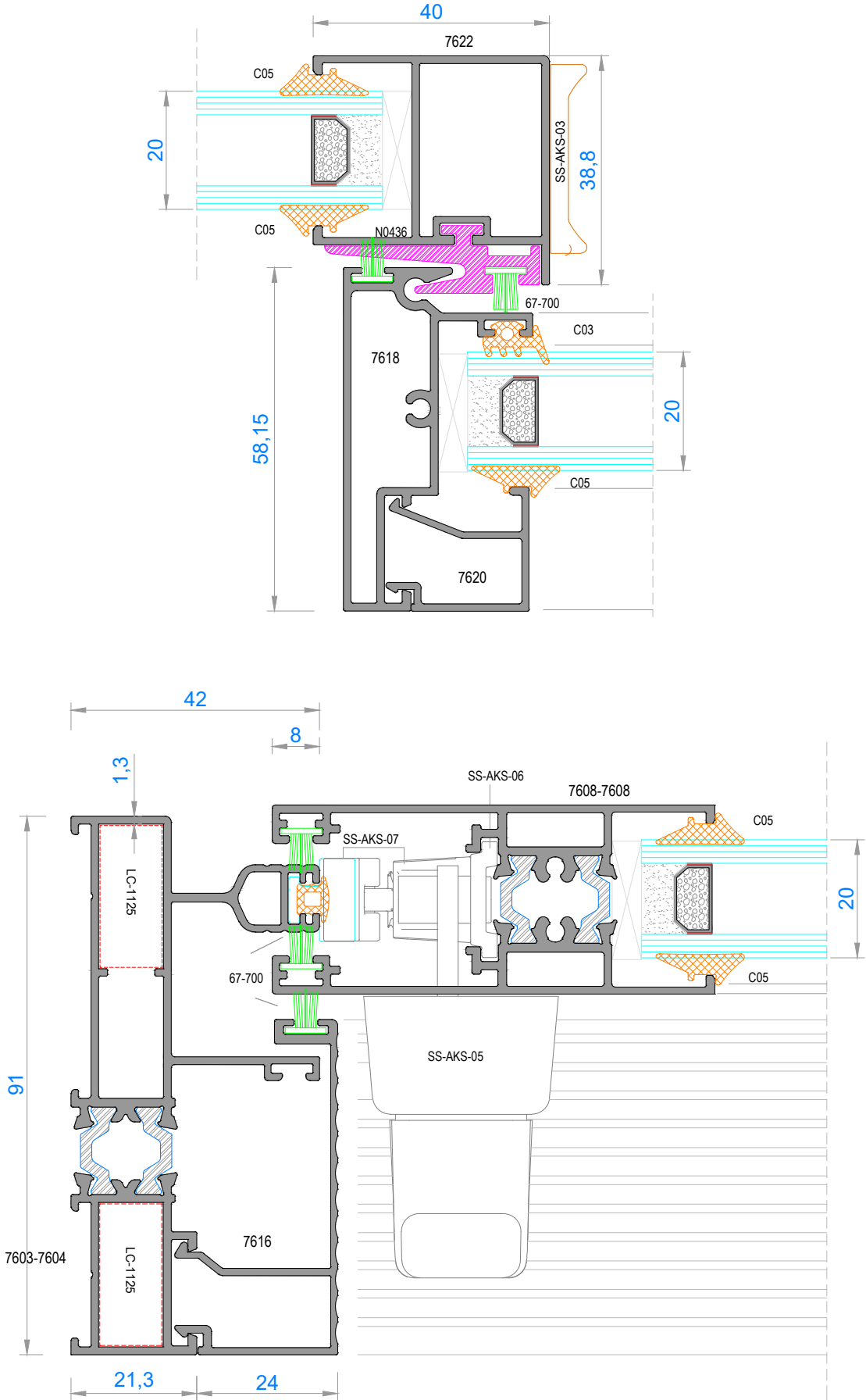

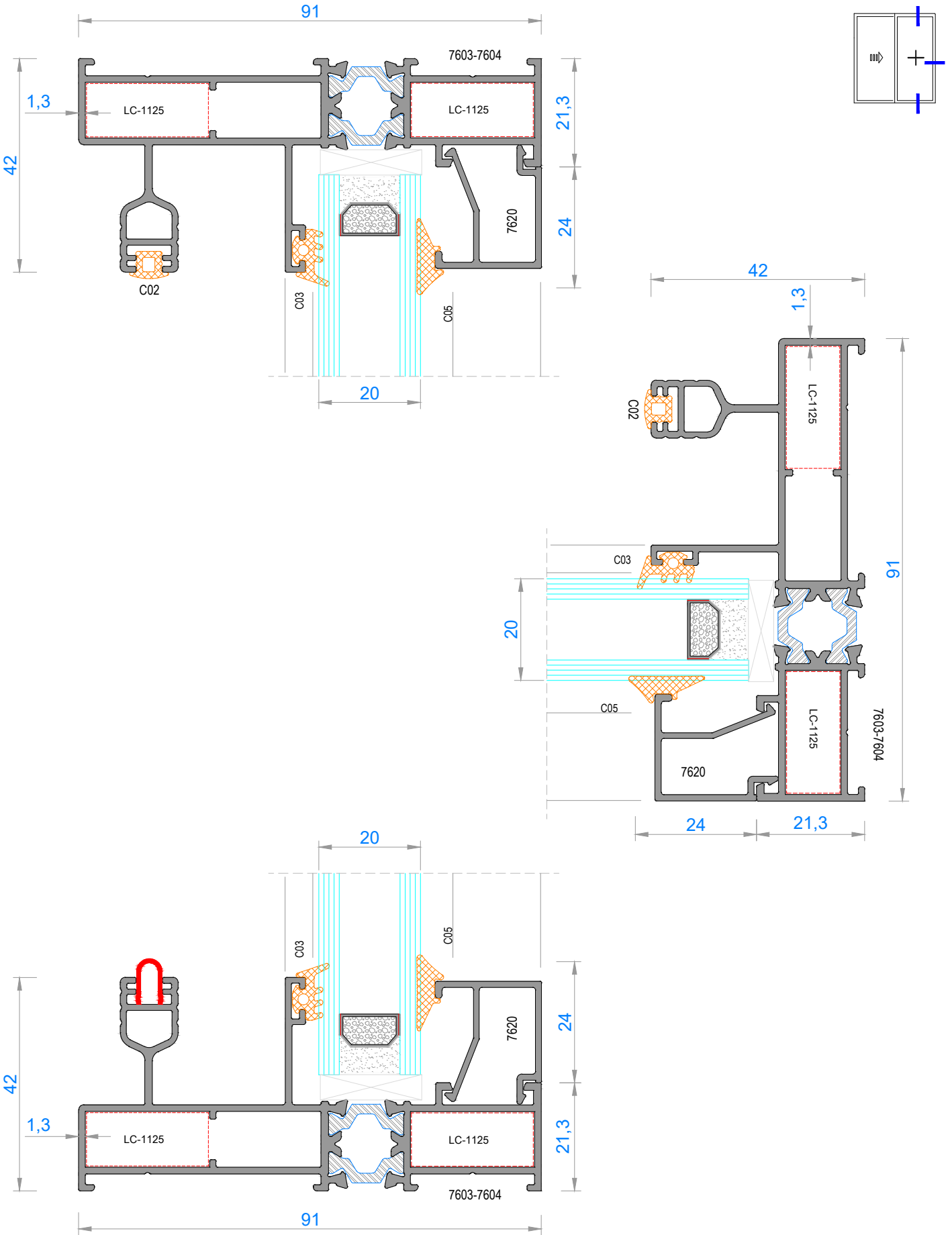

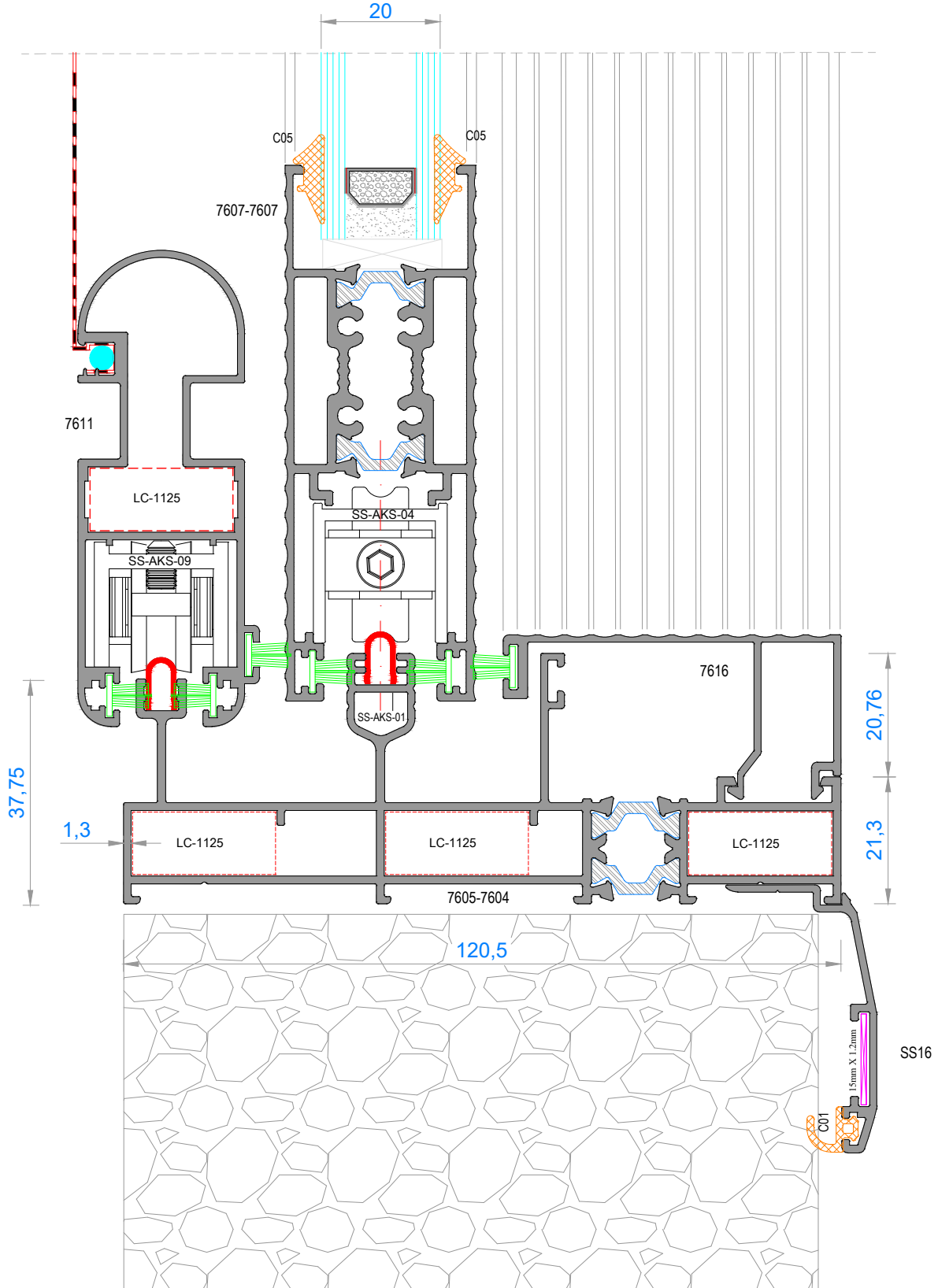
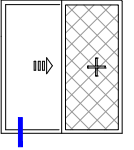

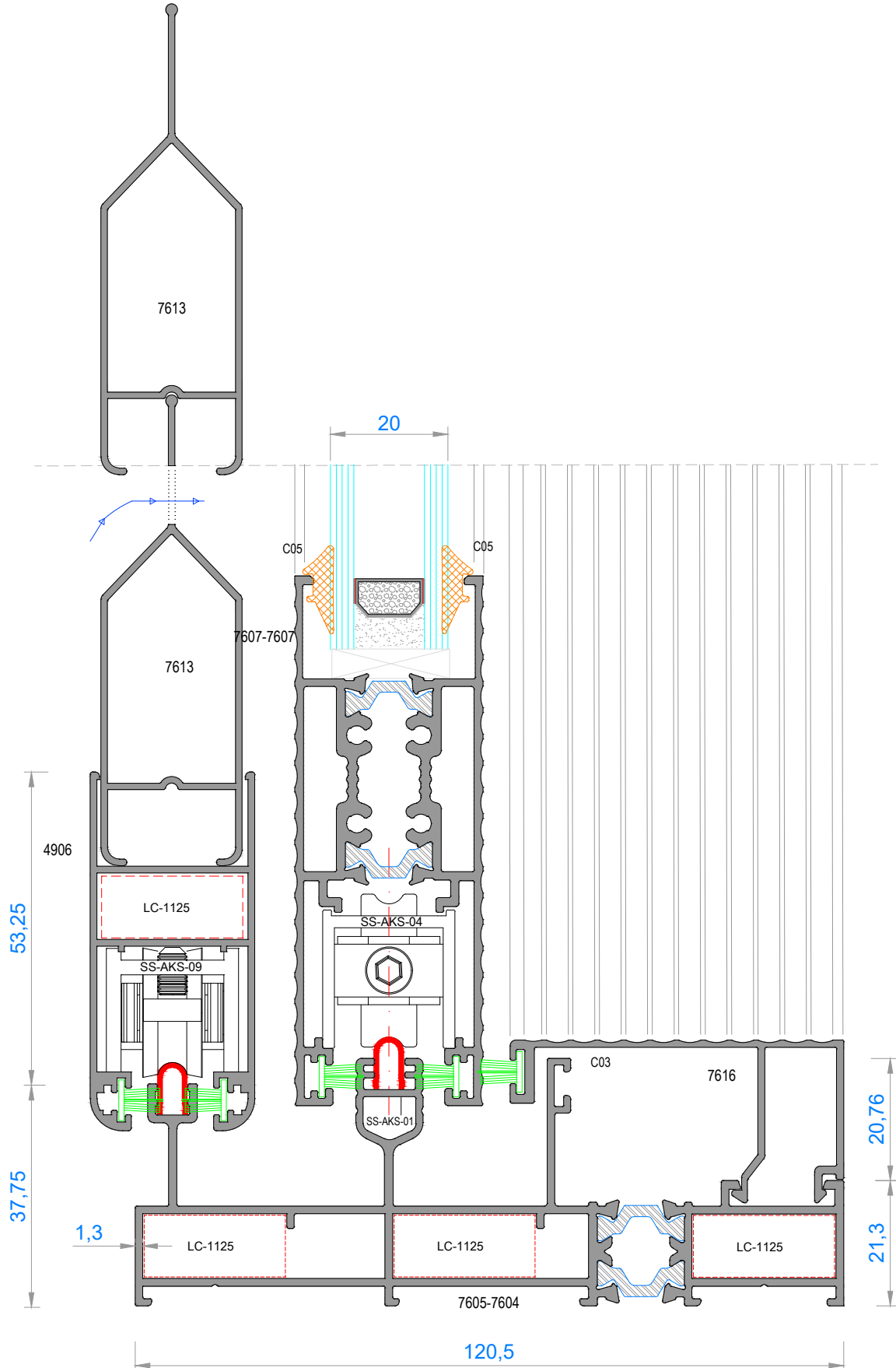
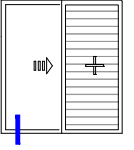

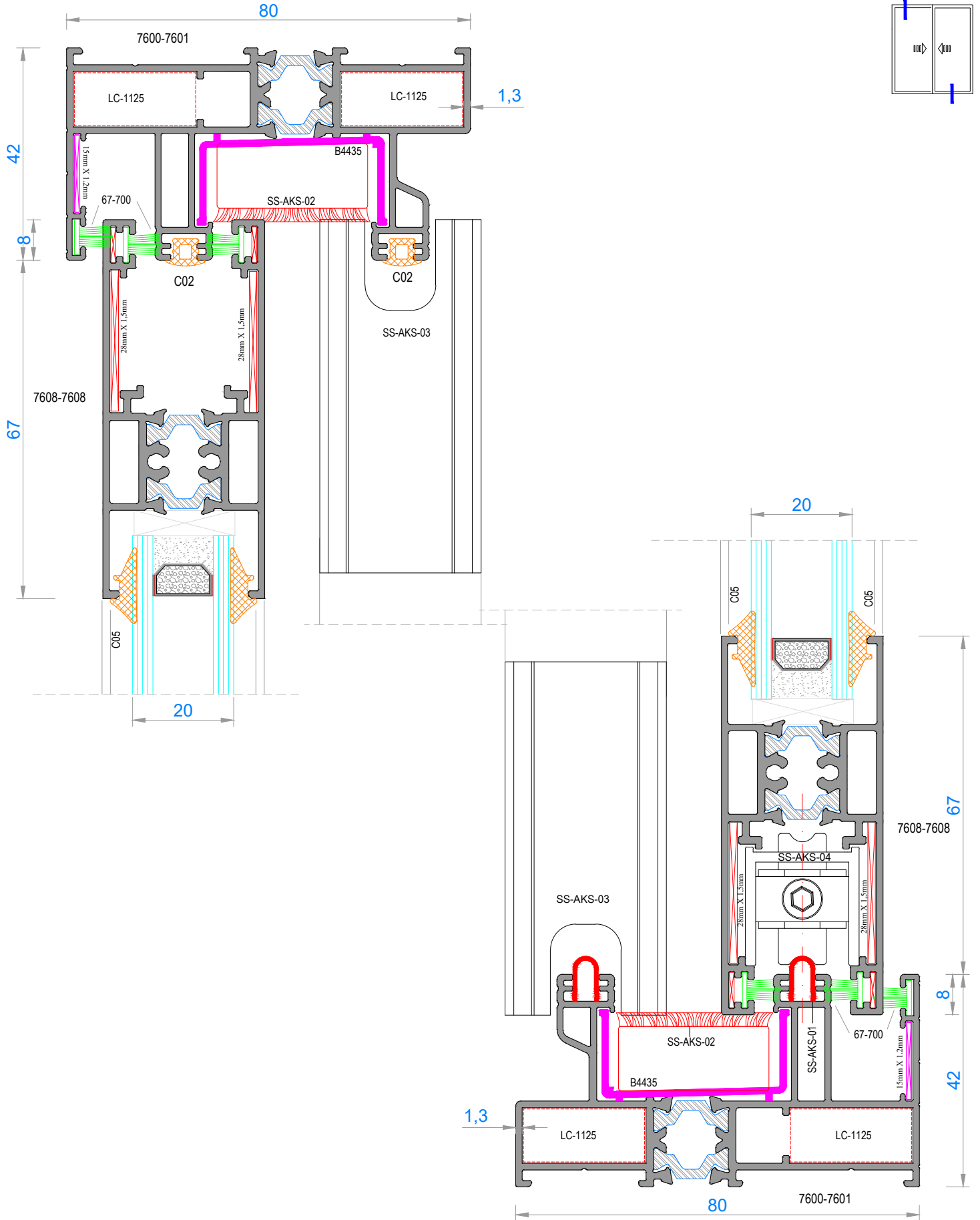

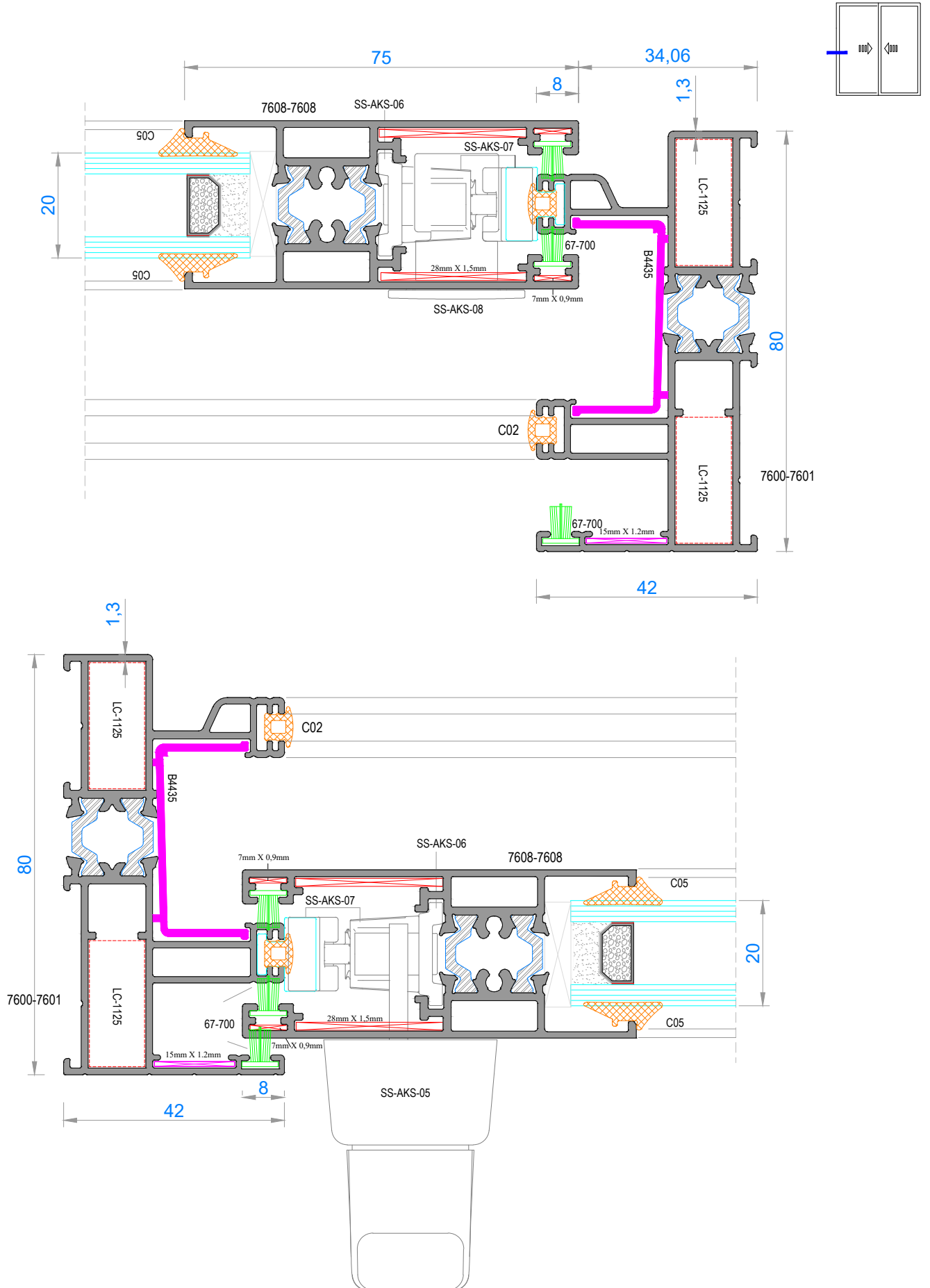

NOT: Profil ağırlıkları teoriktir, üretim sonrası ağırlıklar geçerlidir.

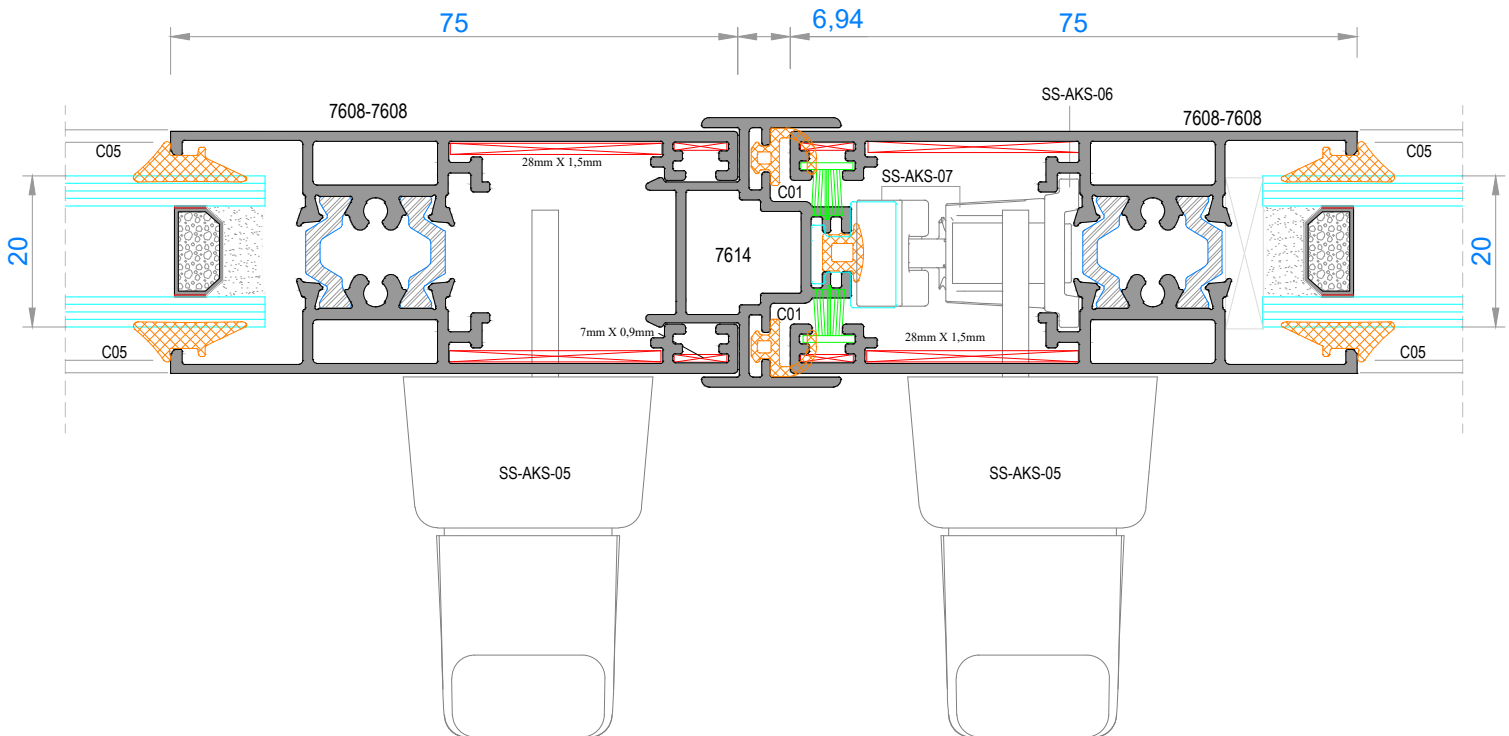
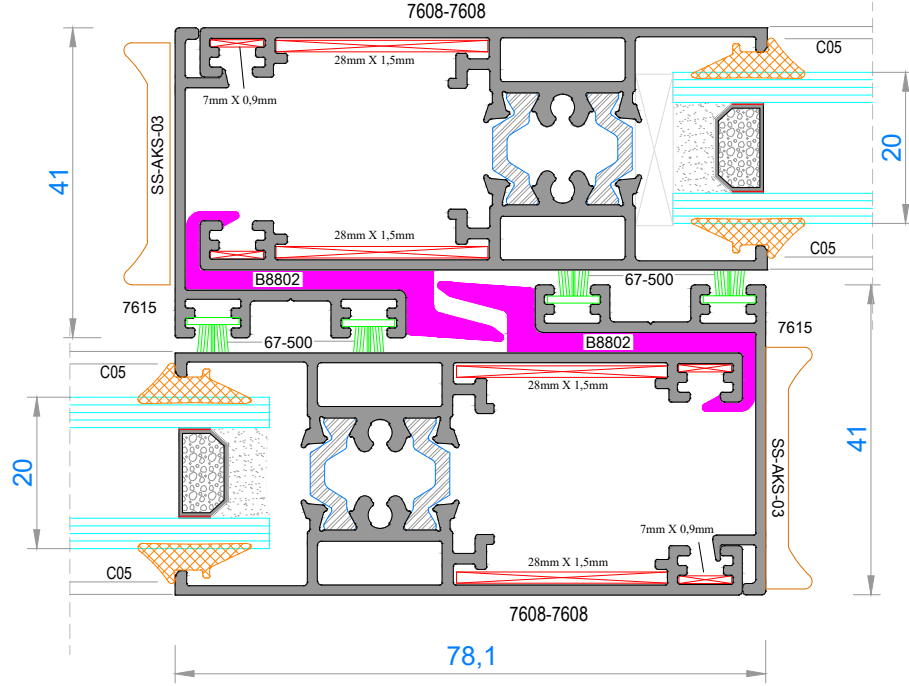
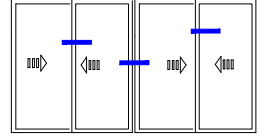

NOT: Profil ağırlıkları teoriktir, üretim sonrası ağırlıklar geçerlidir.

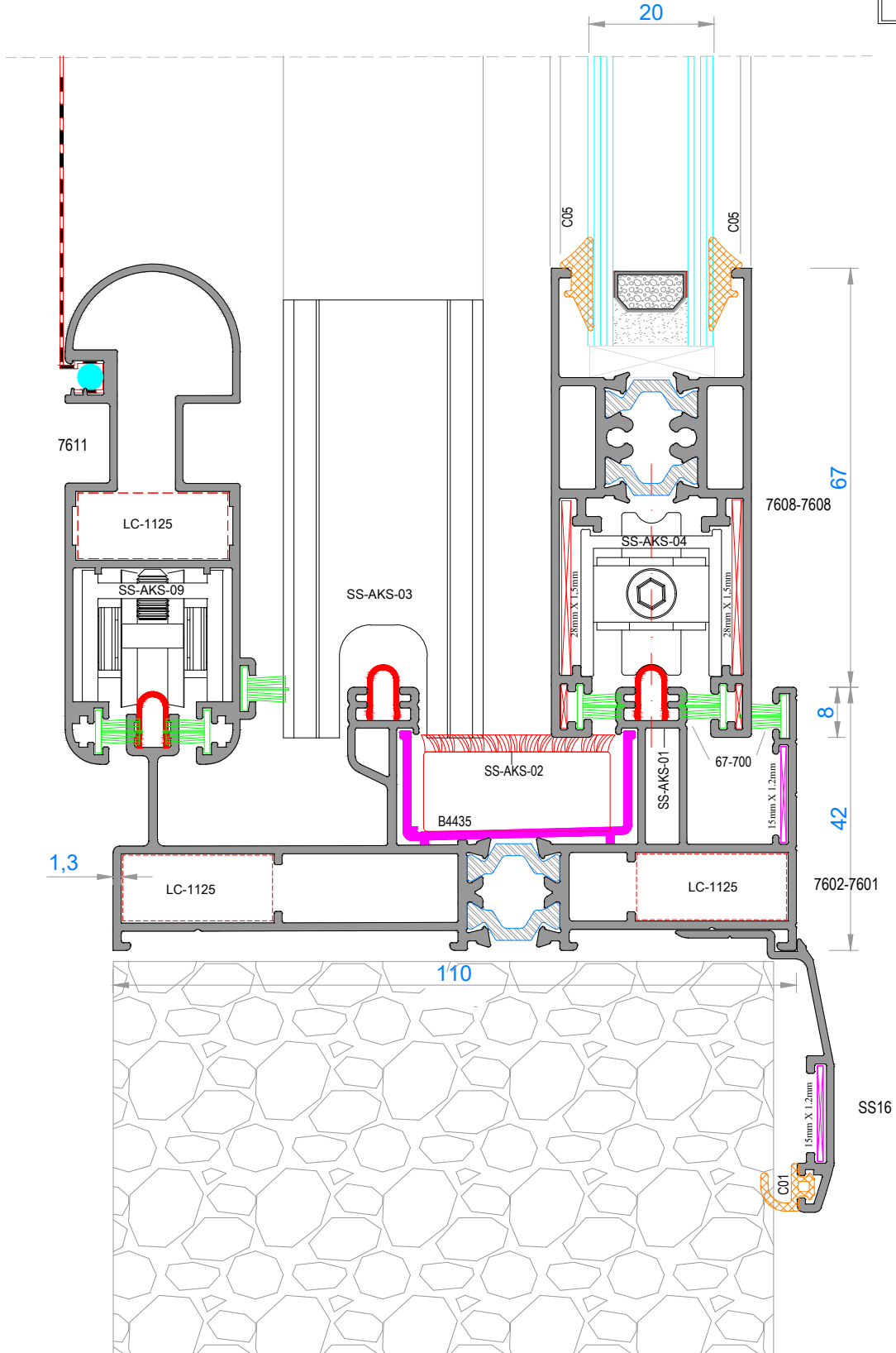
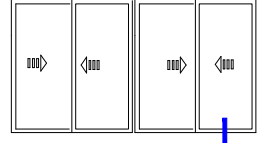

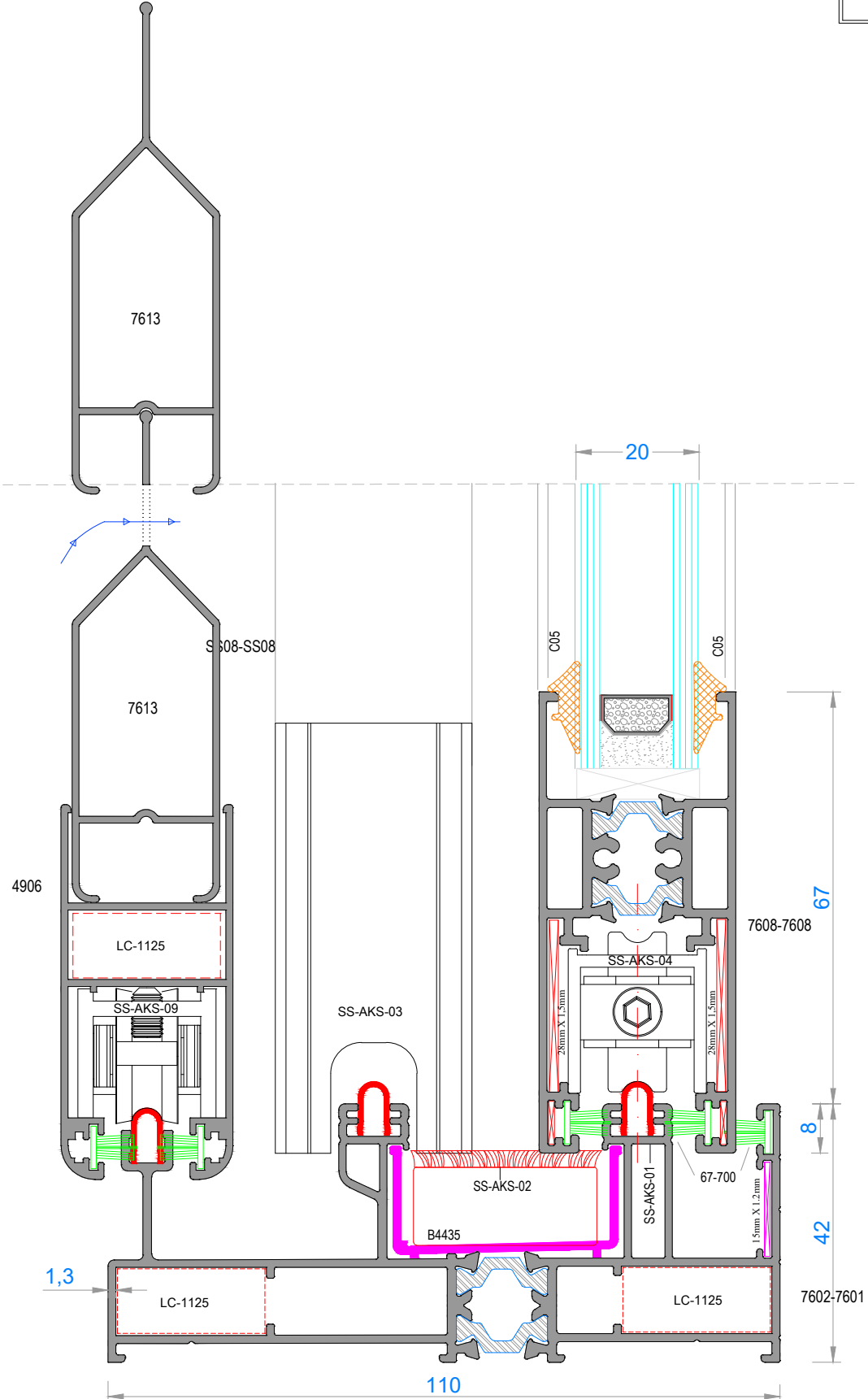
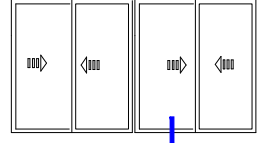

NOT: Profil ağırlıkları teoriktir, üretim sonrası ağırlıklar geçerlidir.

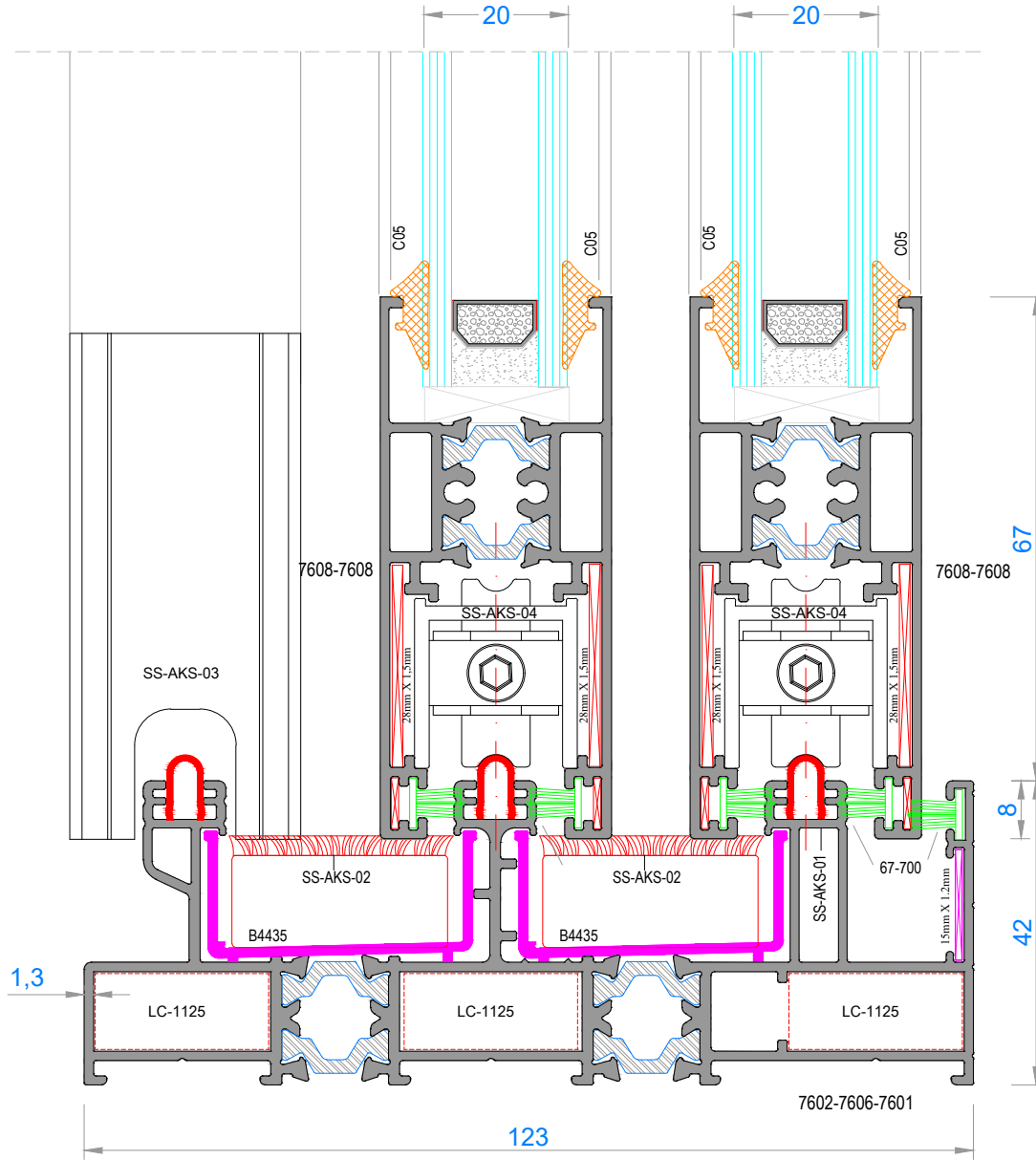
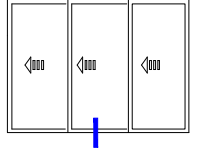

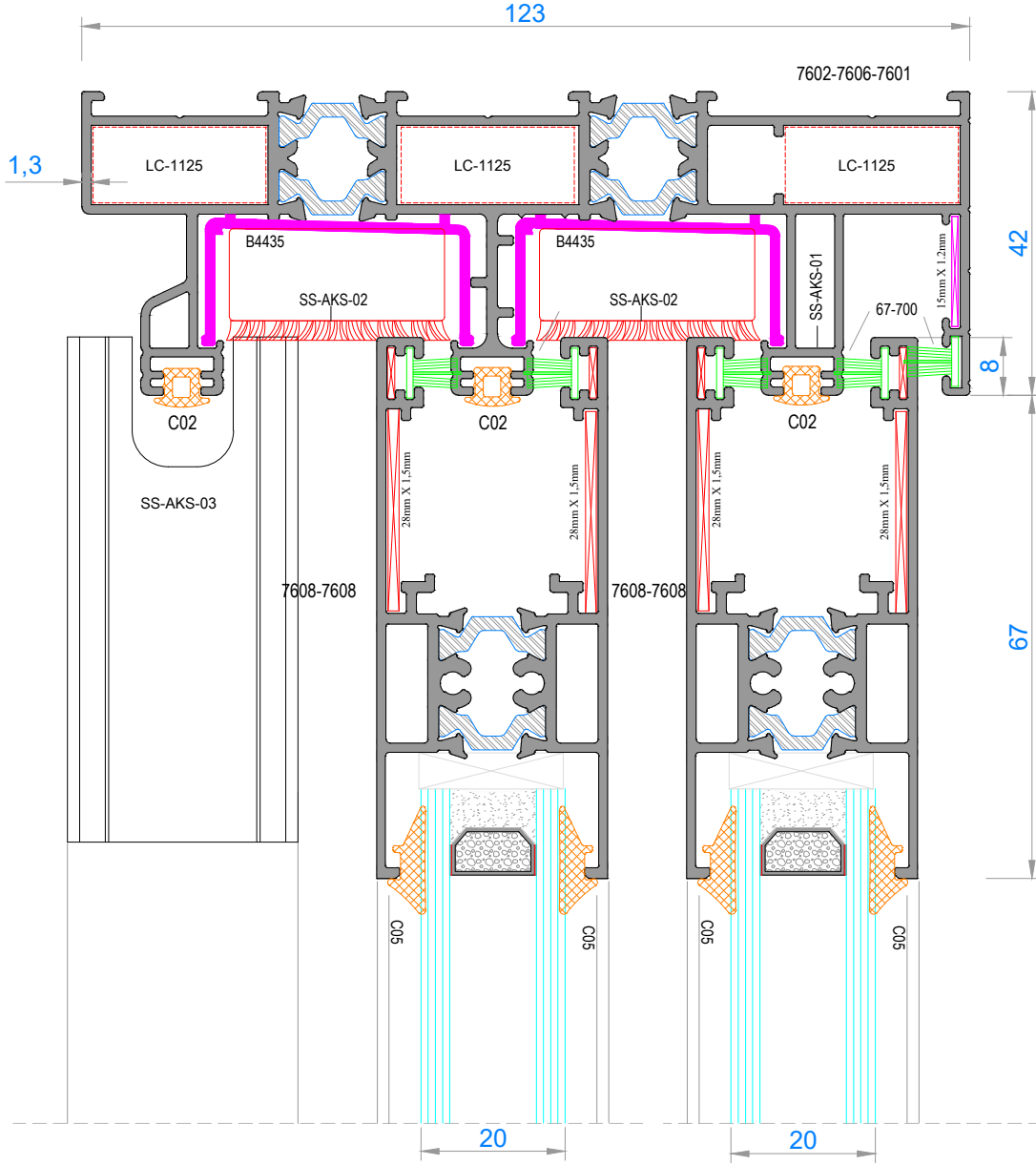
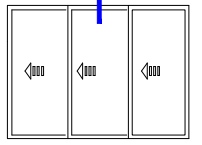

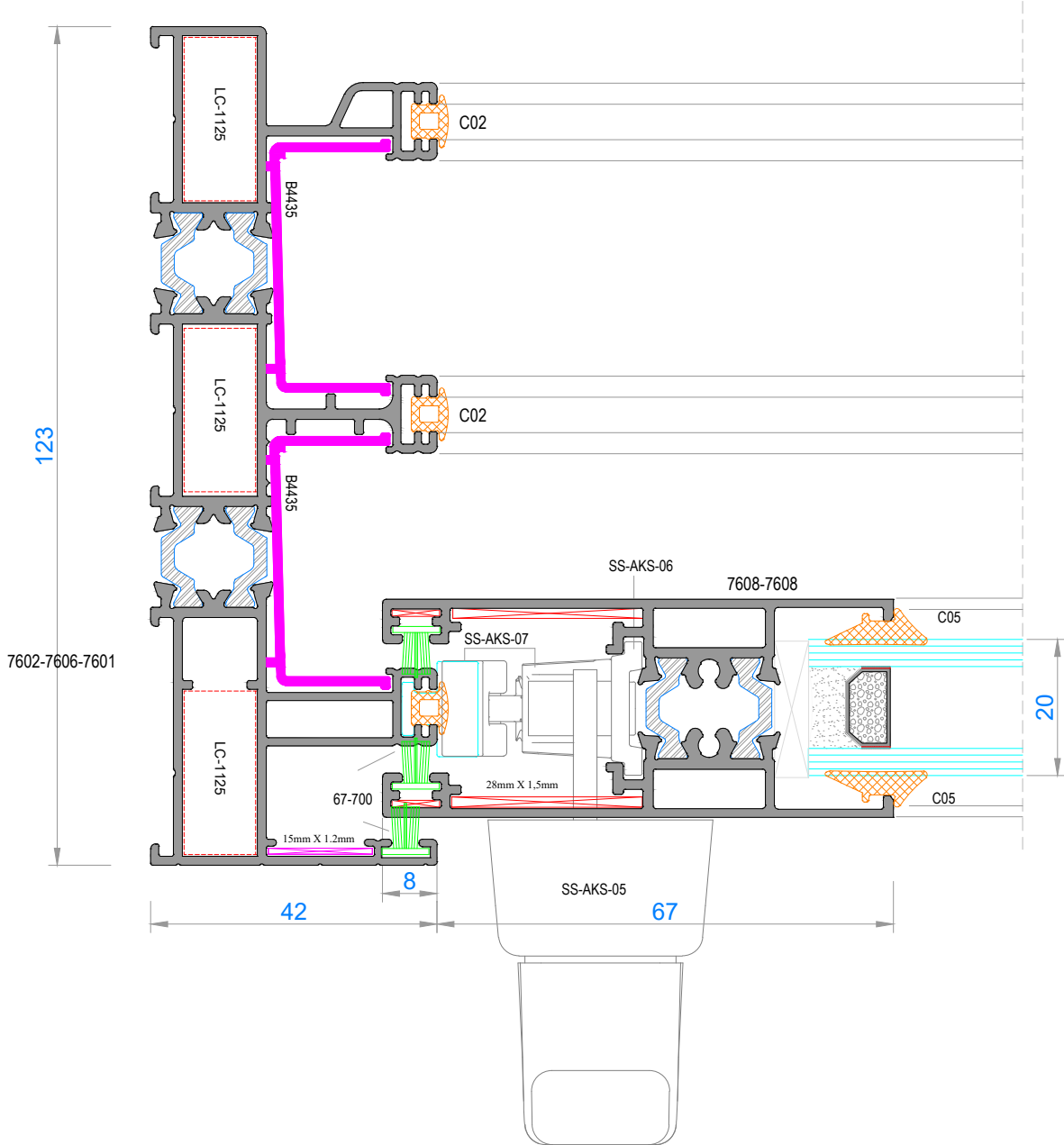
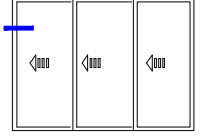

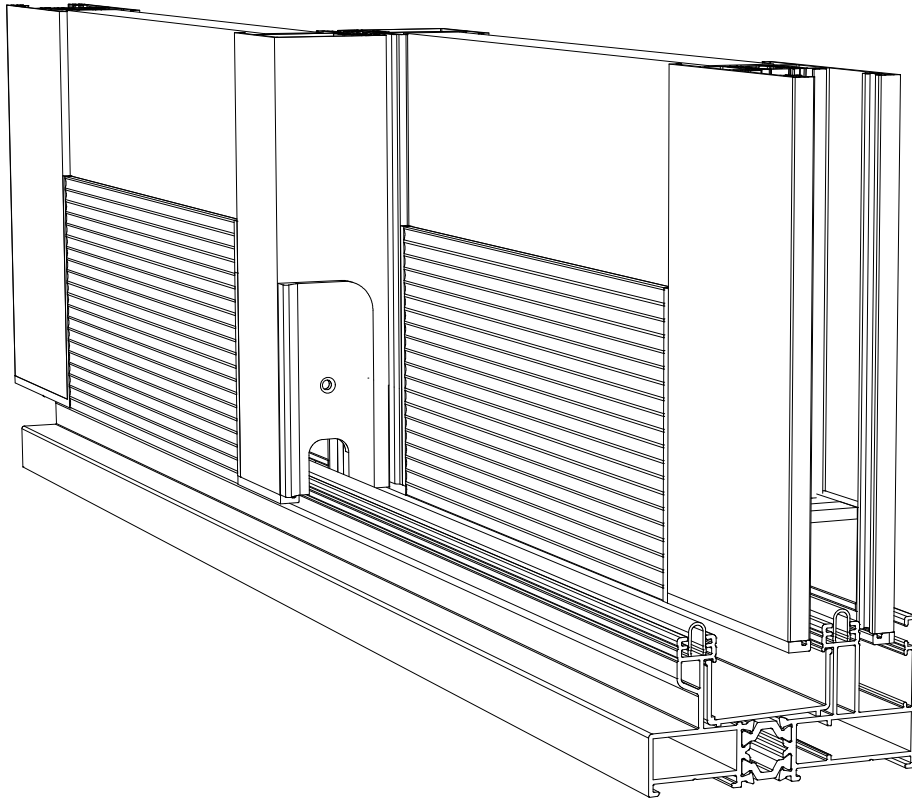

MİMARİ SİSTEMLER

32ST KURULUM VE ÜRETİM ŞEMALARI

32ST INSTALLATION AND PRODUCTION SCHEME

AÇILIM TİPLERİ - OPENING TYPES

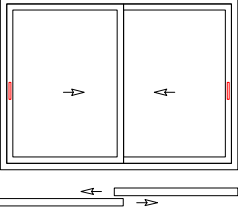

2 HAREKETLİ KANAT
2 SLIDING SASH

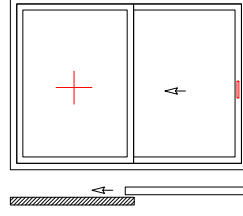

1 HAREKETLİ 1 SABİT KANAT
1 SLIDING 1 FIX SASH

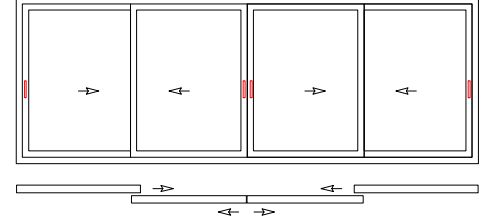

4 HAREKETLİ KANAT
4 SLIDING SASH

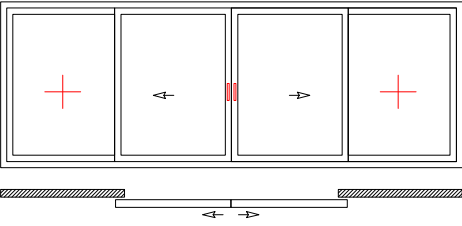

2 HAREKETLİ 2 SABİT KANAT
2 SLIDING 2 FIX SASH

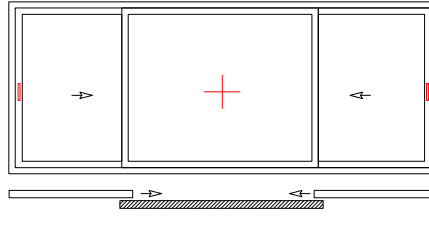

2 HAREKETLİ 1 SABİT KANAT
2 SLIDING 1 FIX SASH

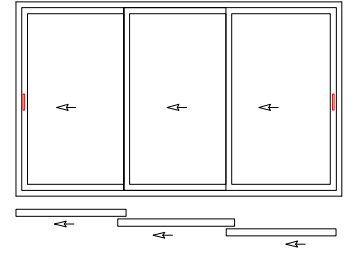

3 HAREKETLİ KANAT
3 SLIDING SASH

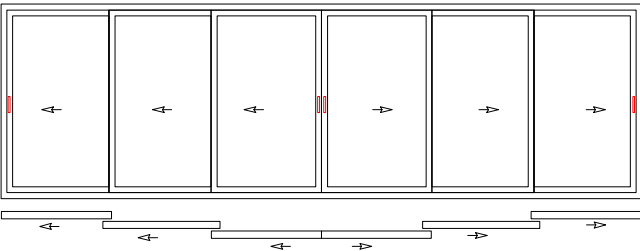

6 HAREKETLİ KANAT
6 SLIDING SASH

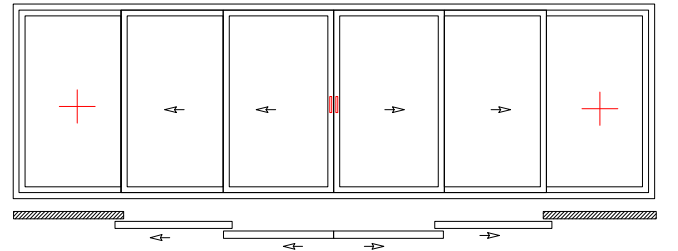

4 HAREKETLİ 2 SABİT KANAT
4 SLIDING 2 FIX SASH

STATİK DİYAGRAMLAR - STATIC DIAGRAMS

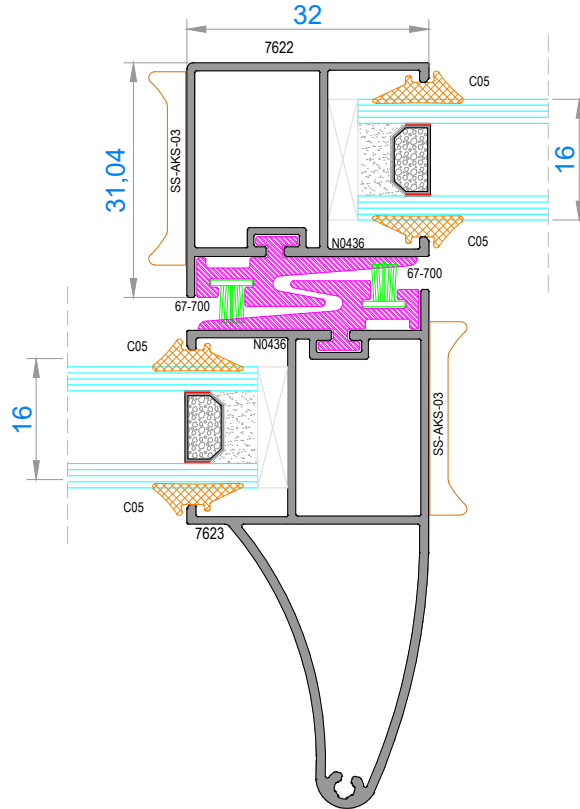
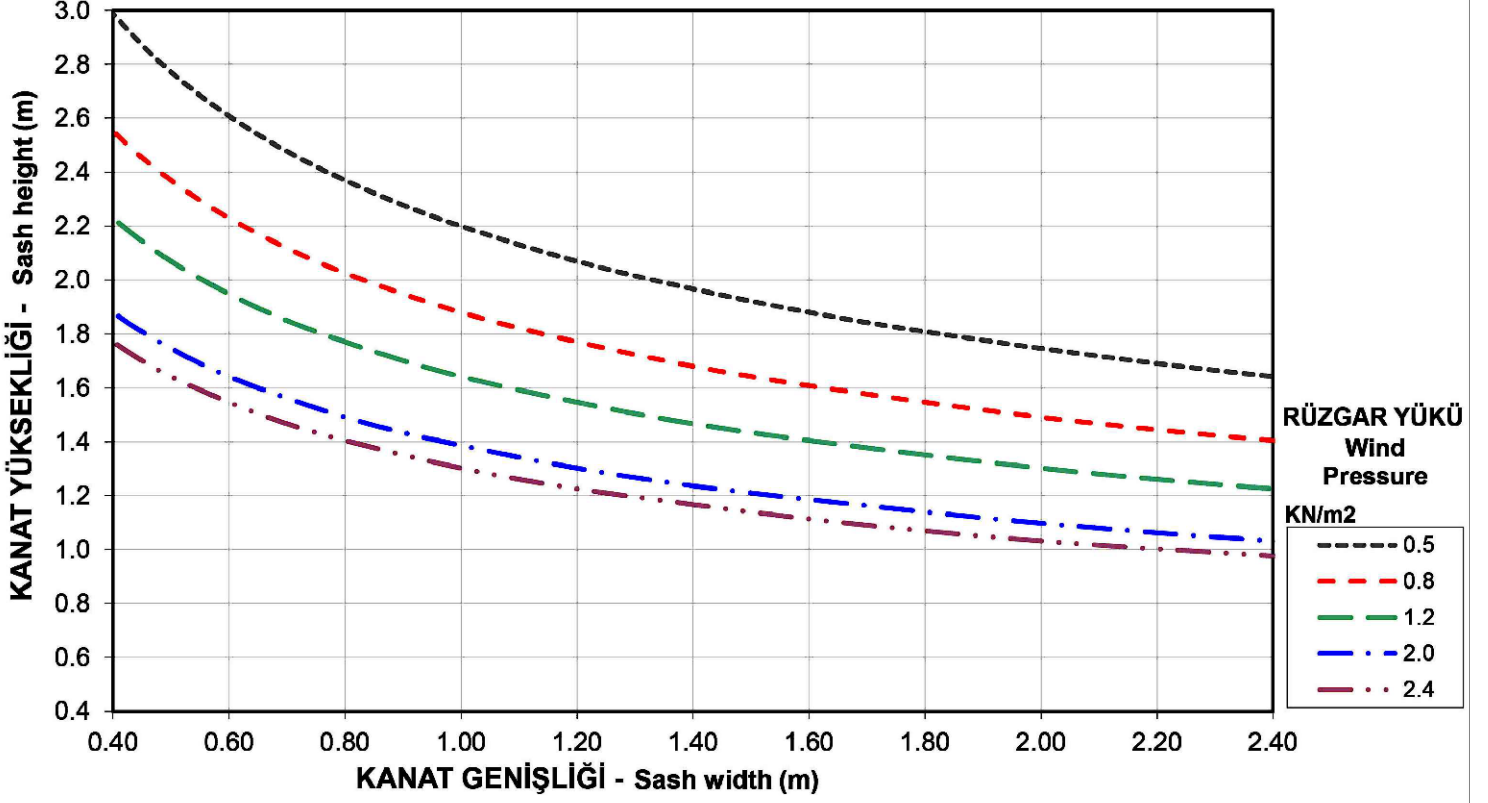

NOT: Profil ağırlıkları teoriktir, üretim sonrası ağırlıklar geçerlidir.

KASA MONTAJ ŞEMASI - FRAME ASSEMBLY SCHEME

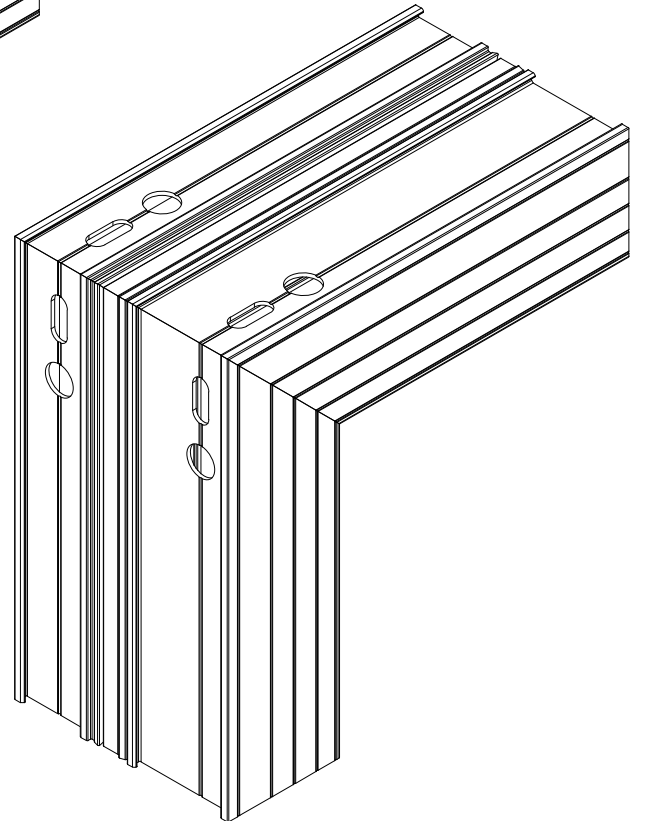
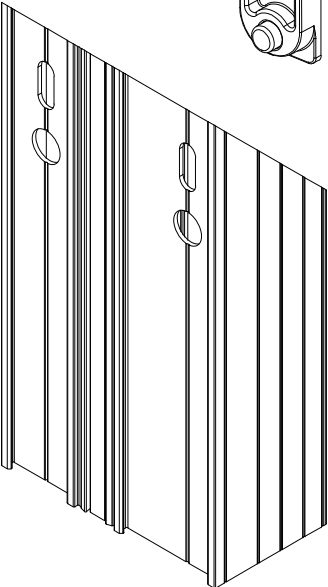
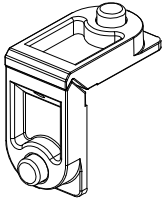
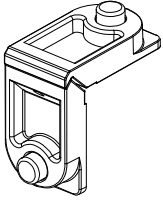
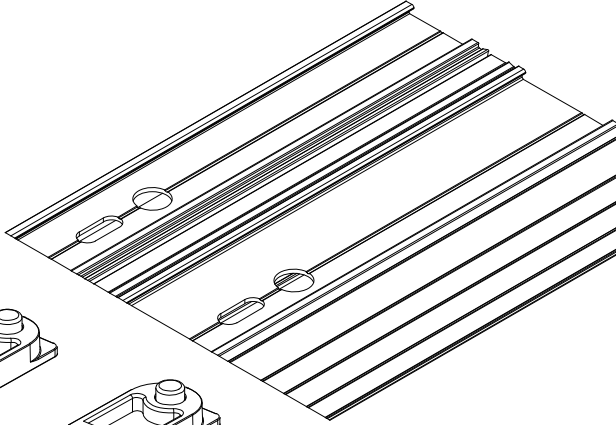
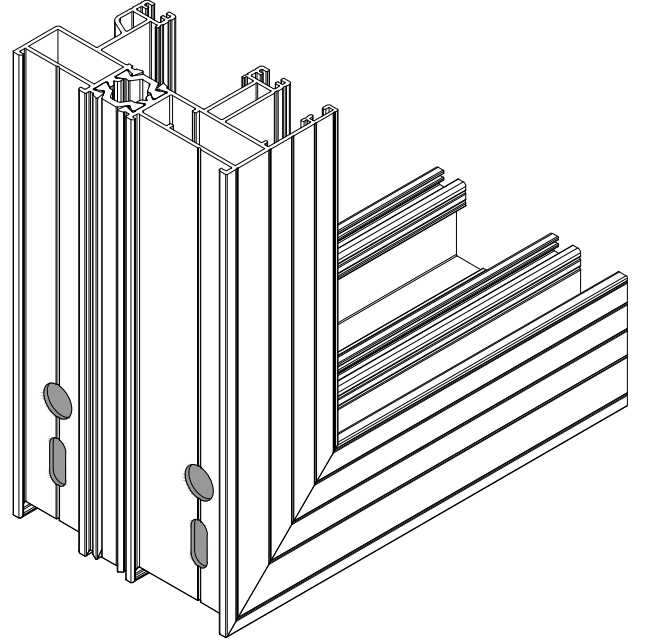
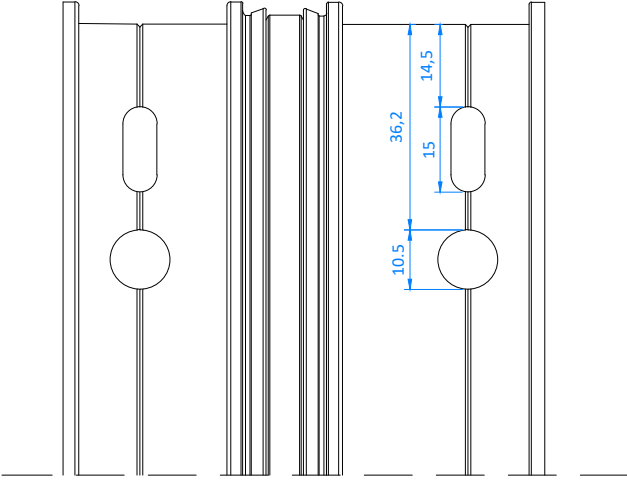

SU TAHLİYE MONTAJ ŞEMASI - WATER EMPTYING ASSEMBLY SCHEME

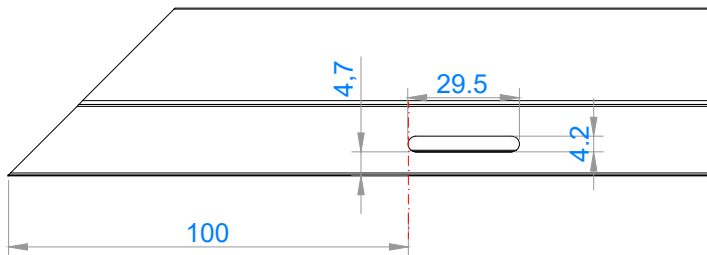
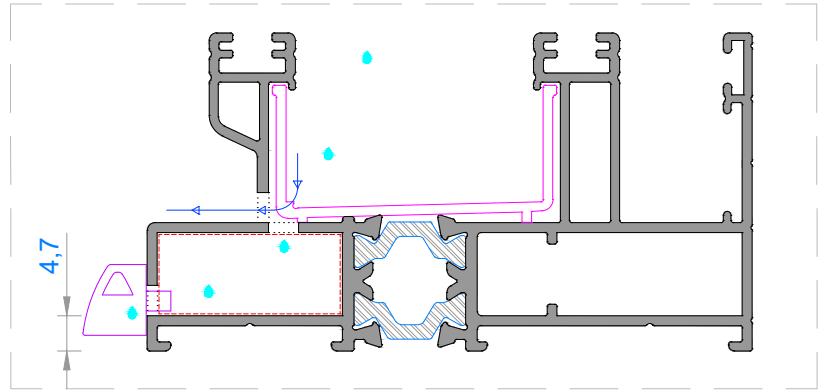
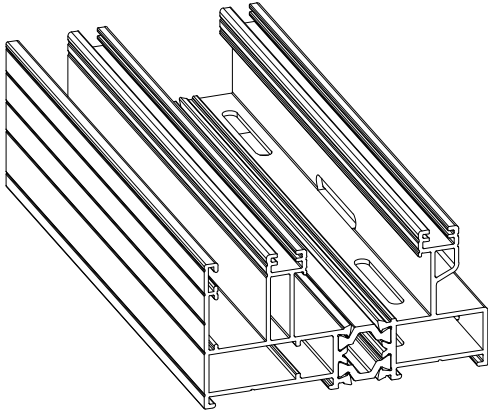
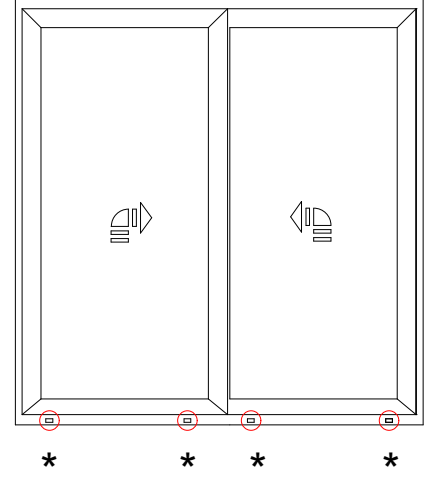
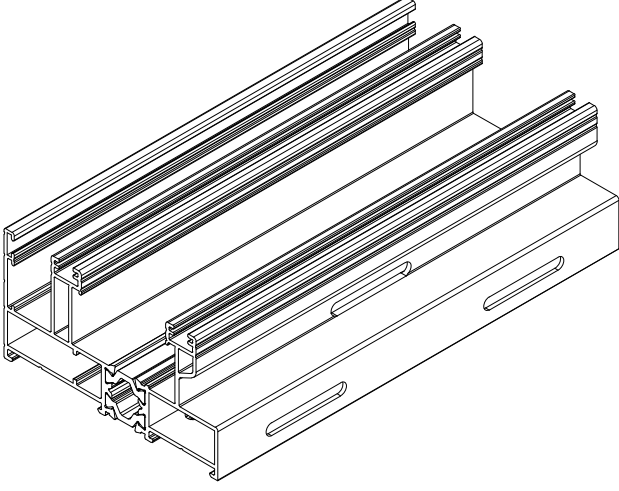

NOT: Profil ağırlıkları teoriktir, üretim sonrası ağırlıklar geçerlidir.

AKSESUAR MONTAJ ŞEMASI - ACCESSORY ASSEMBLY SCHEME

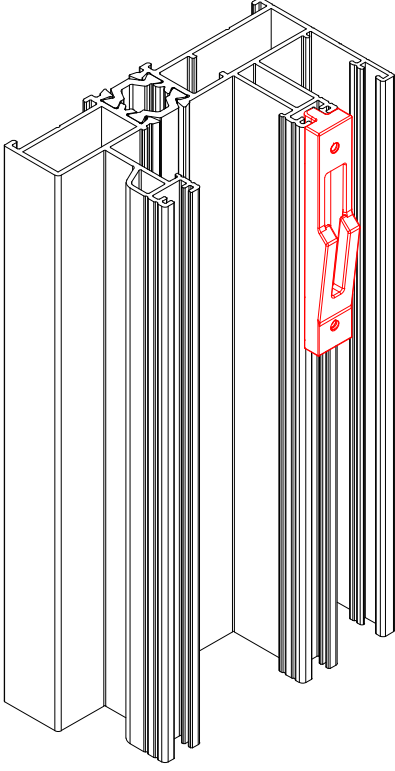

SS-AKS-07

Kilit karşılığı kasa profilleri köşe birleştirme işlemi yapılmadan önce yerine takılmalı.

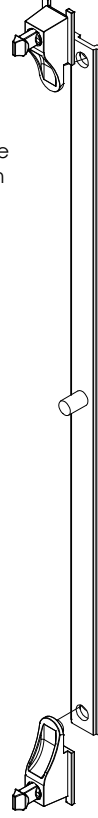

SS-AKS-06



SS-AKS-08

SS-AKS-07

SS-AKS-07

Kilit karşılığı kasa profilleri köşe birleştirme işlemi yapılmadan önce yerine takılmalı.

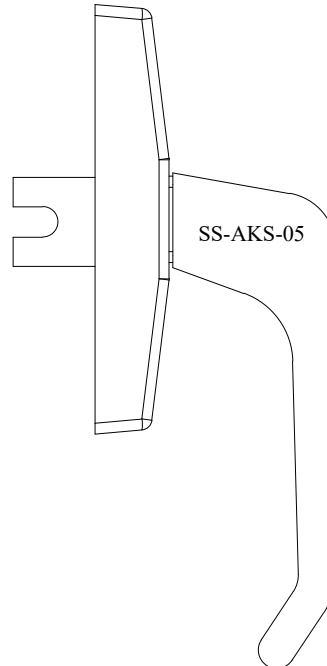
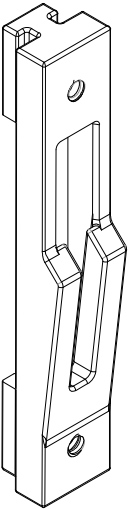

SS-AKS-05

90° KANAT MONTAJ ŞEMASI - SASH ASSEMBLY SCHEME

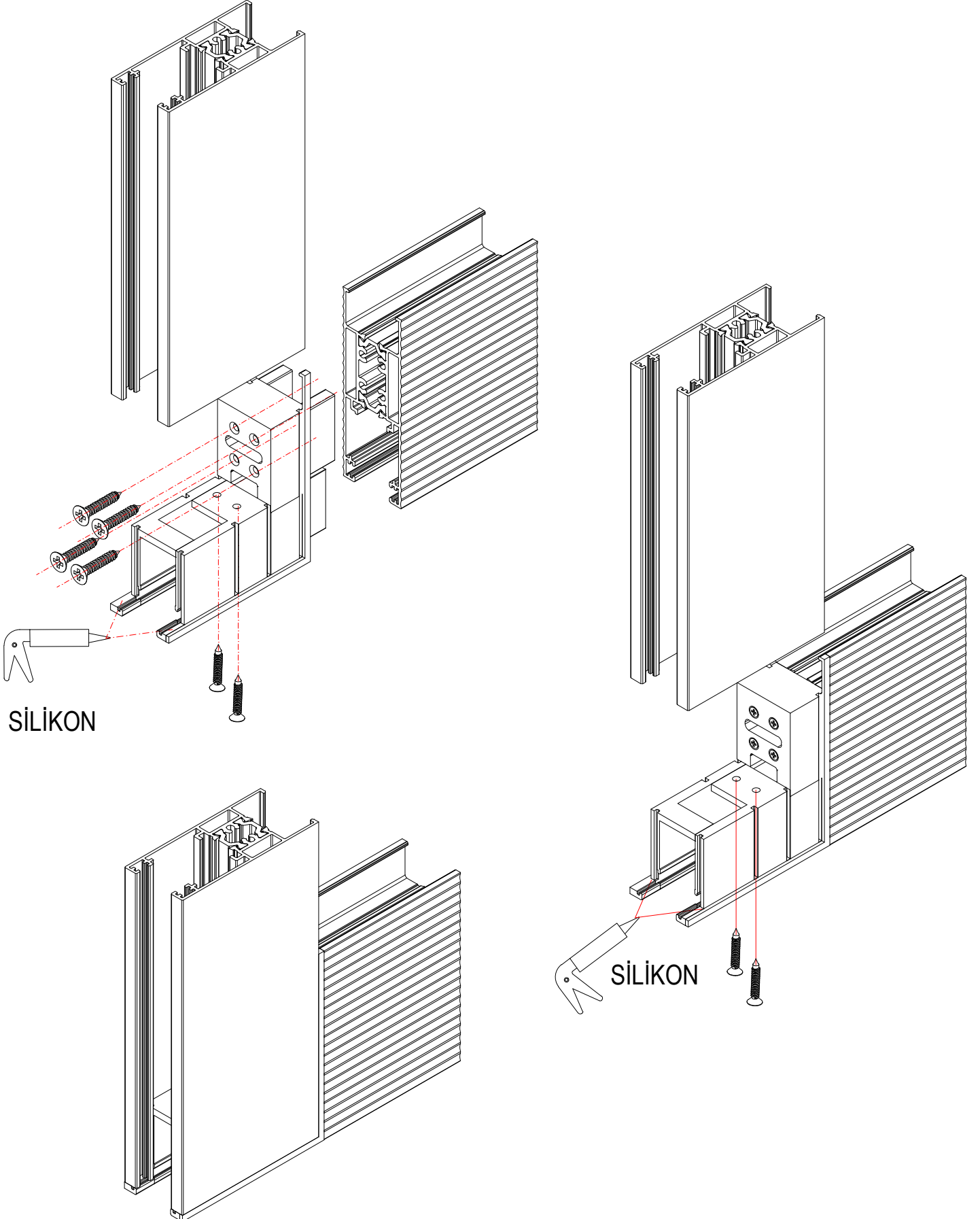

90° KANAT MONTAJ ŞEMASI - SASH ASSEMBLY SCHEME

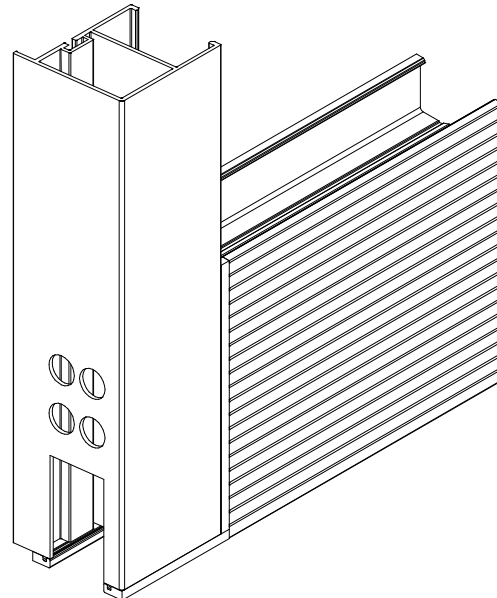
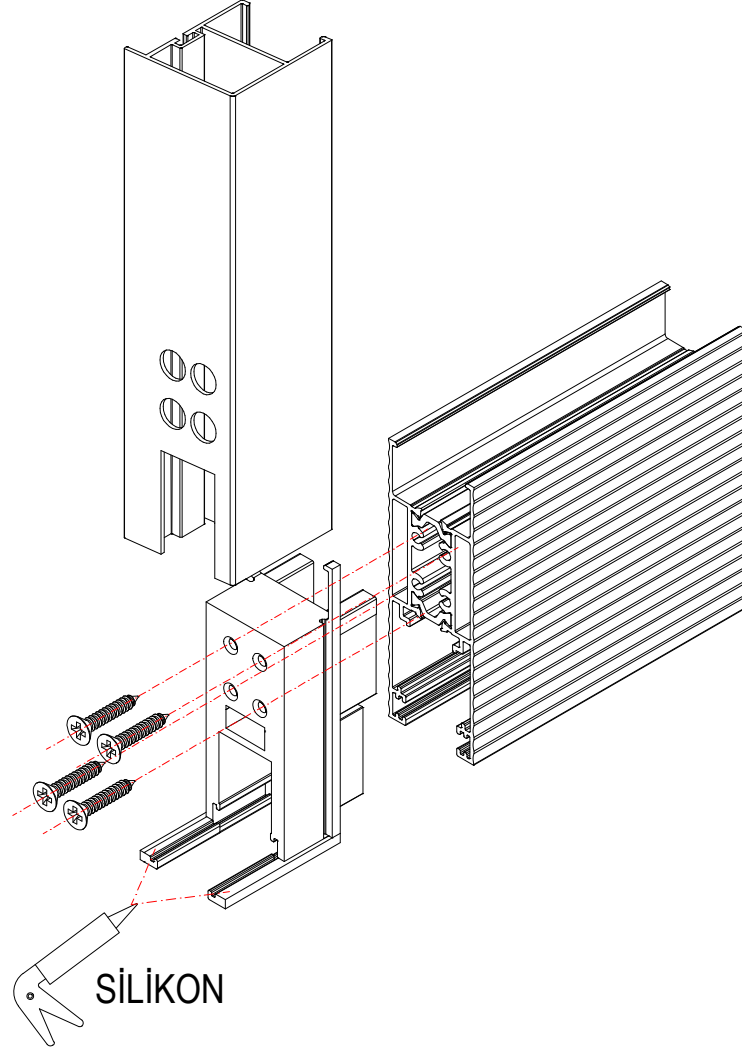

NOT: Profil ağırlıkları teoriktir, üretim sonrası ağırlıklar geçerlidir.

KENET KAPAĞI MONTAJ ŞEMASI - LOCKING COVER ASSEMBLY SCHEME

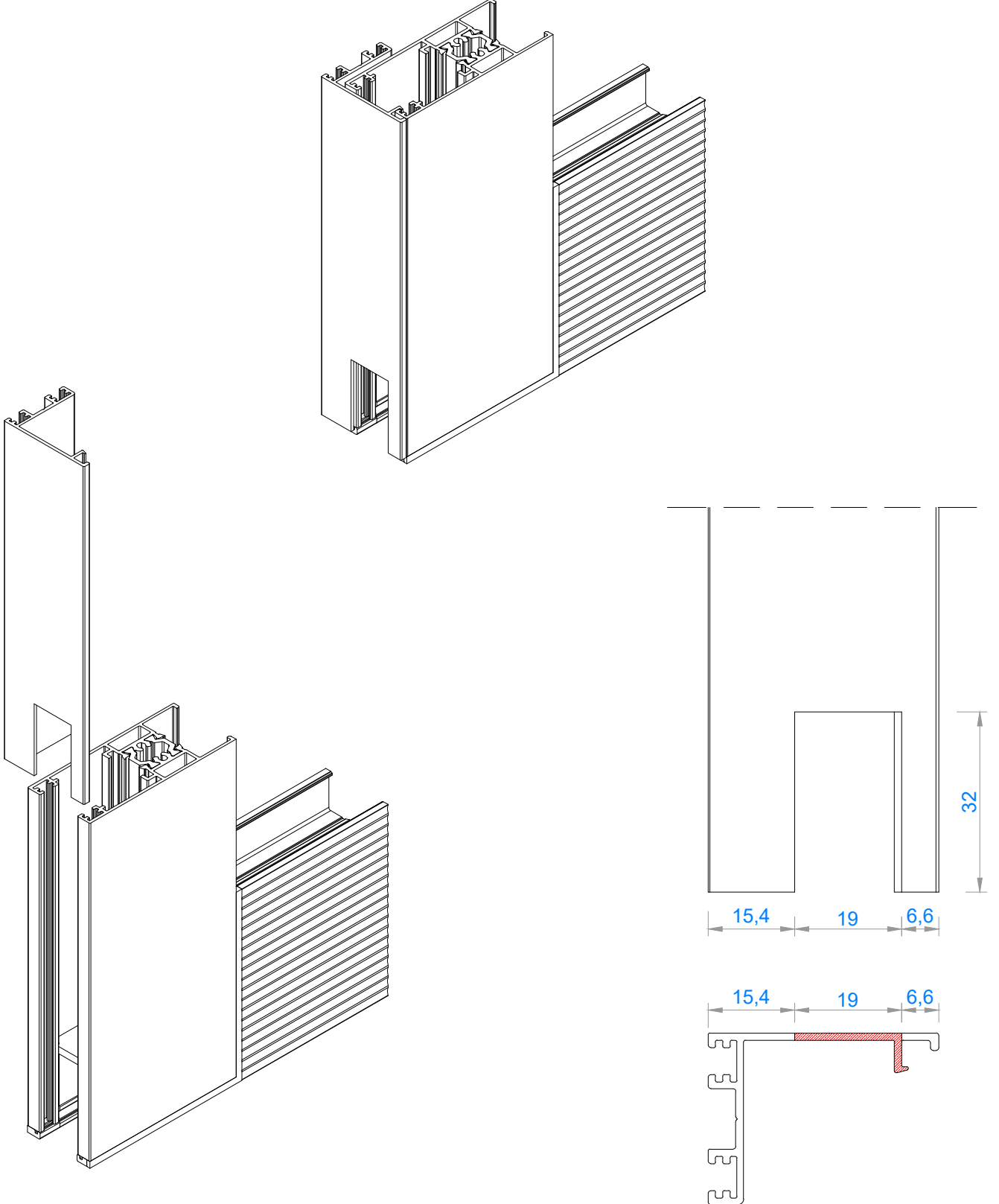

KOL MONTAJ ŞEMASI - HANDLE ASSEMBLY SCHEME

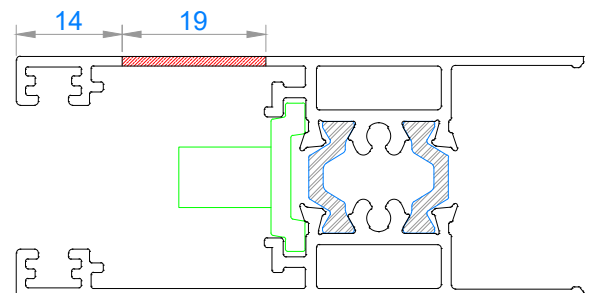
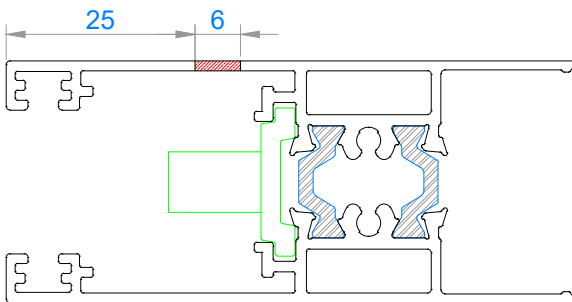
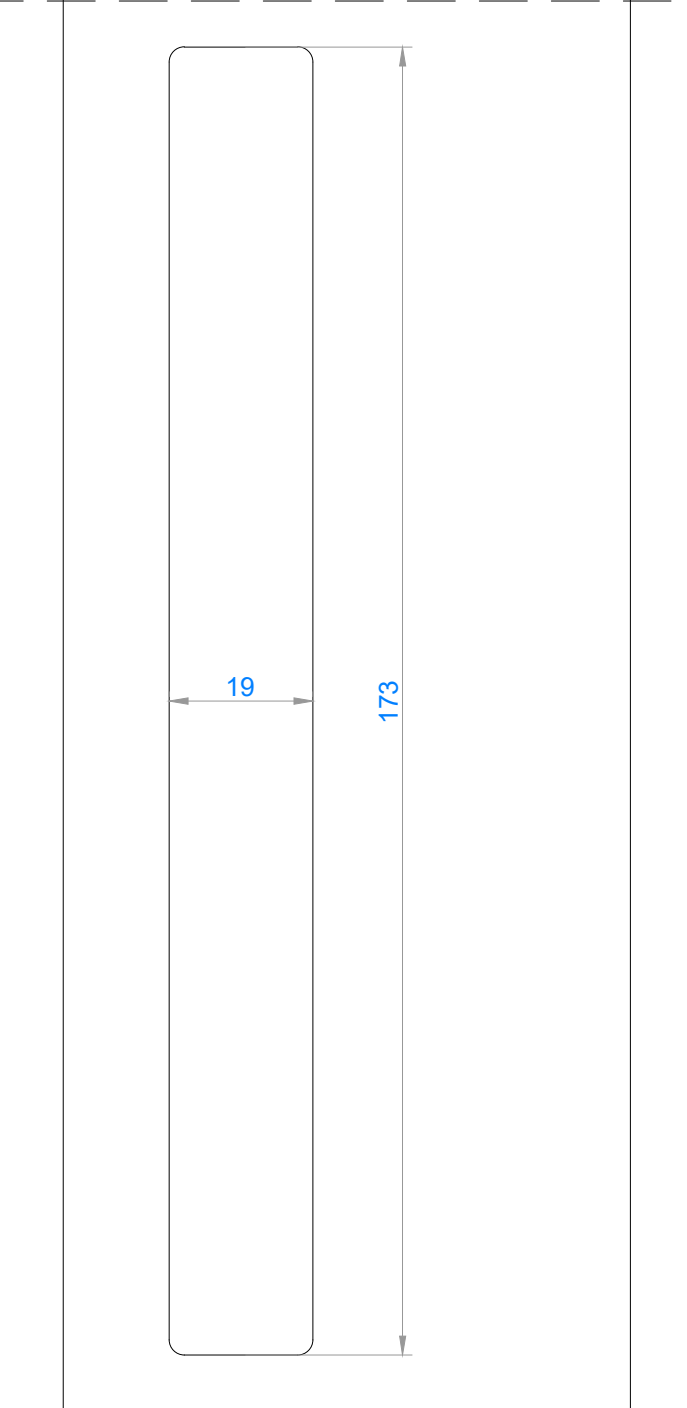
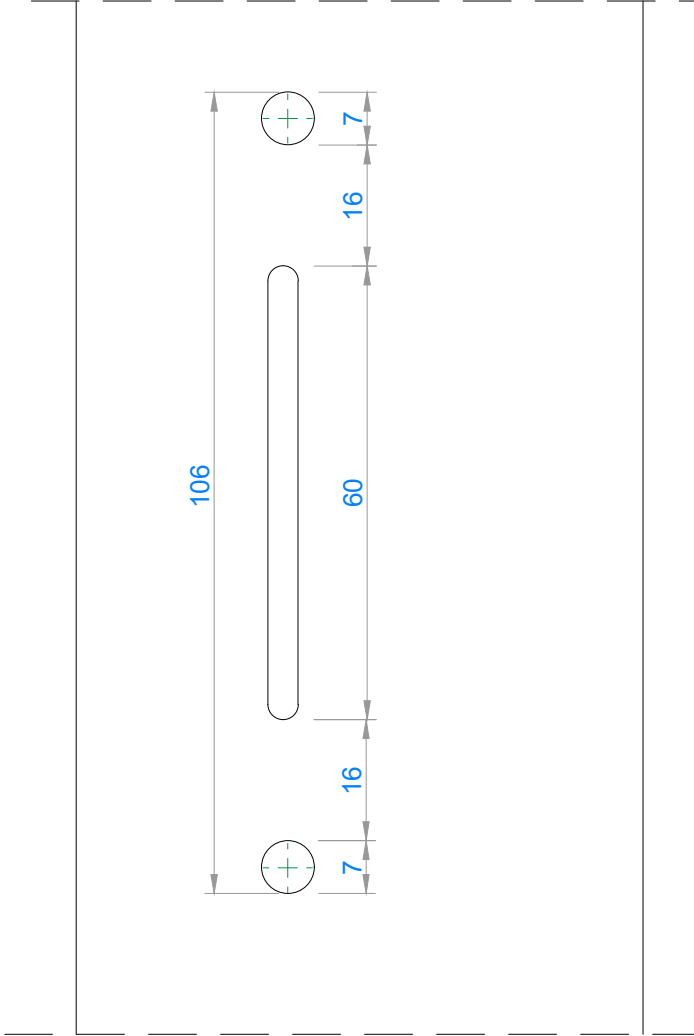

NOT: Profil ağırlıkları teoriktir, üretim sonrası ağırlıklar geçerlidir.

KENET MONTAJ ŞEMASI - LOCKING ASSEMBLY SCHEME

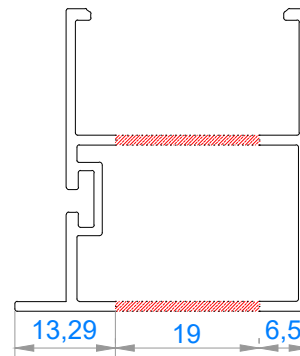
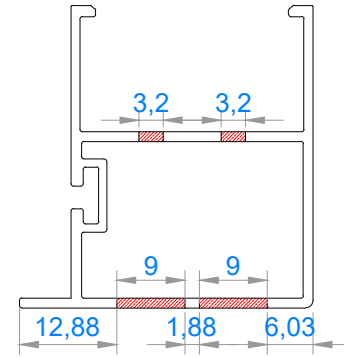
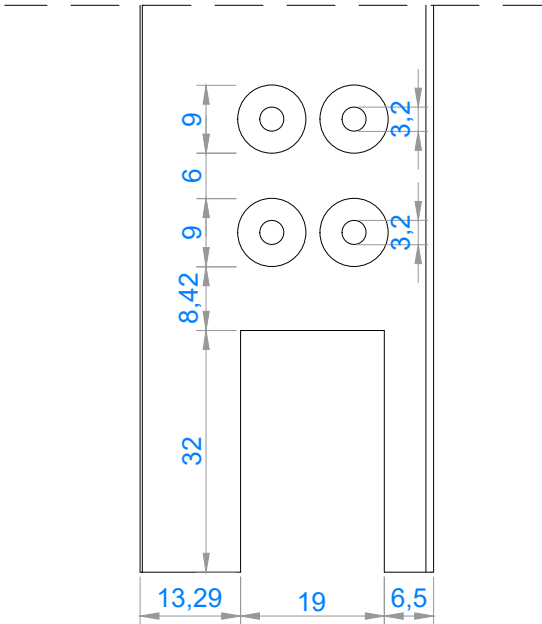
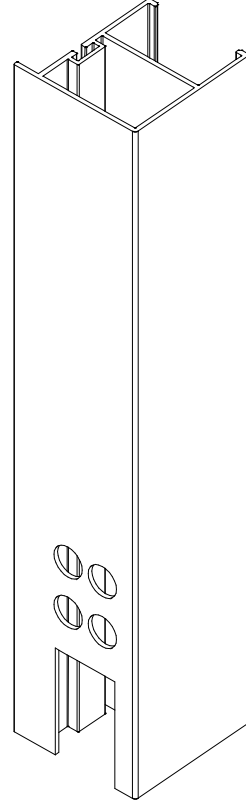
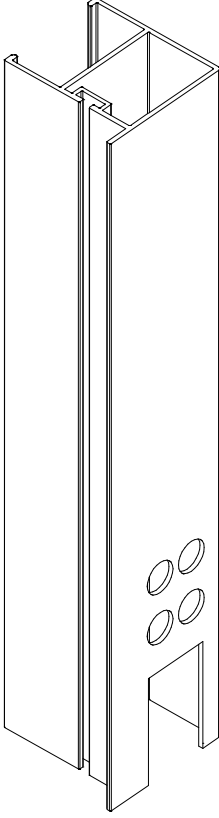

KENET MONTAJ ŞEMASI - LOCKING ASSEMBLY SCHEME

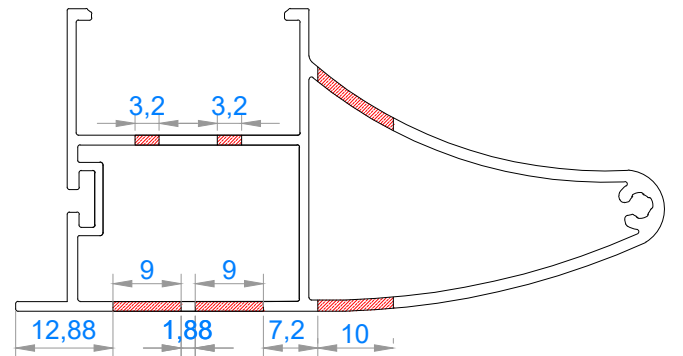
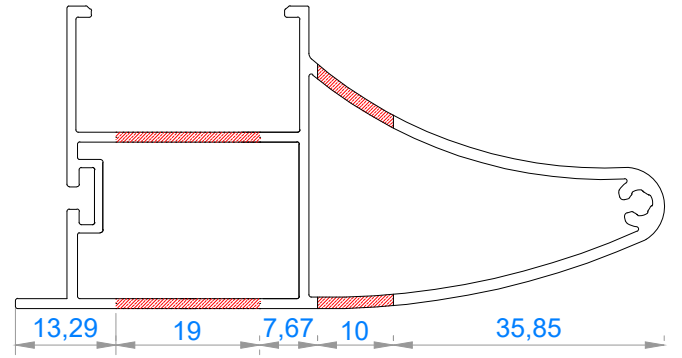
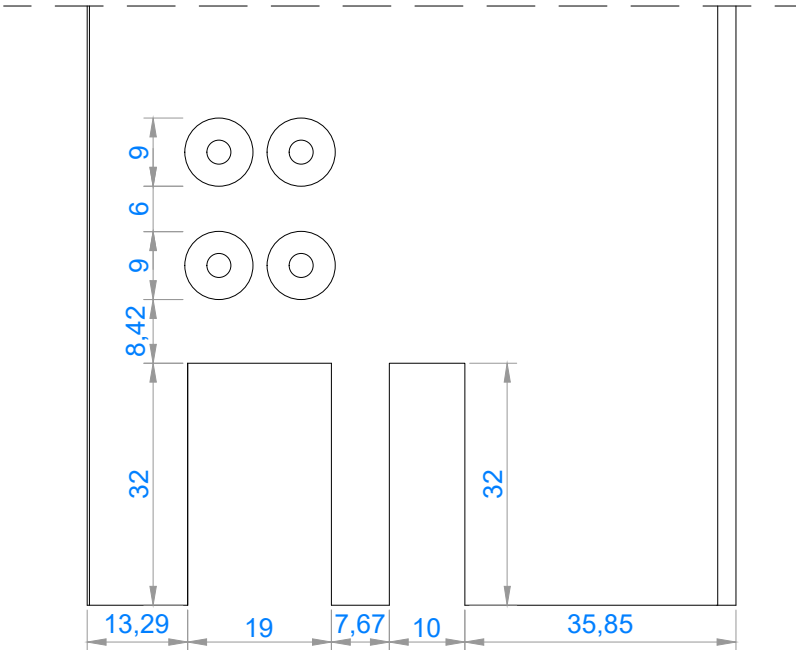
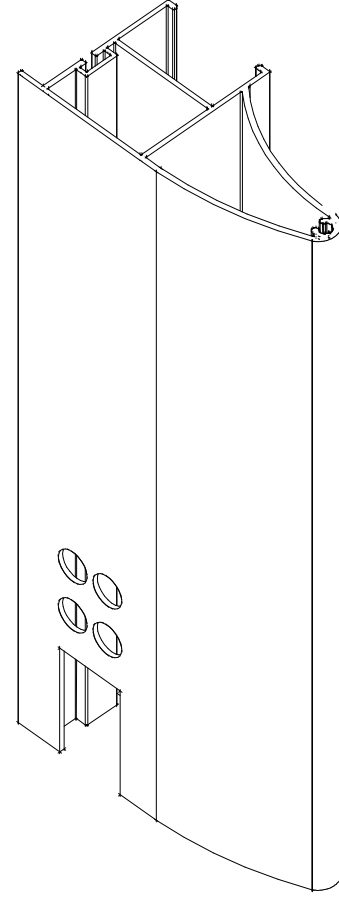
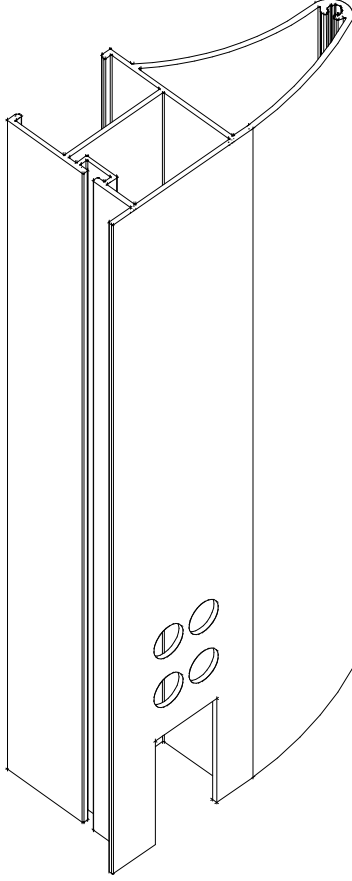

PVC İSPANYOLET MONTAJI - PVC LOCKING ASSEMBLY SCHEME

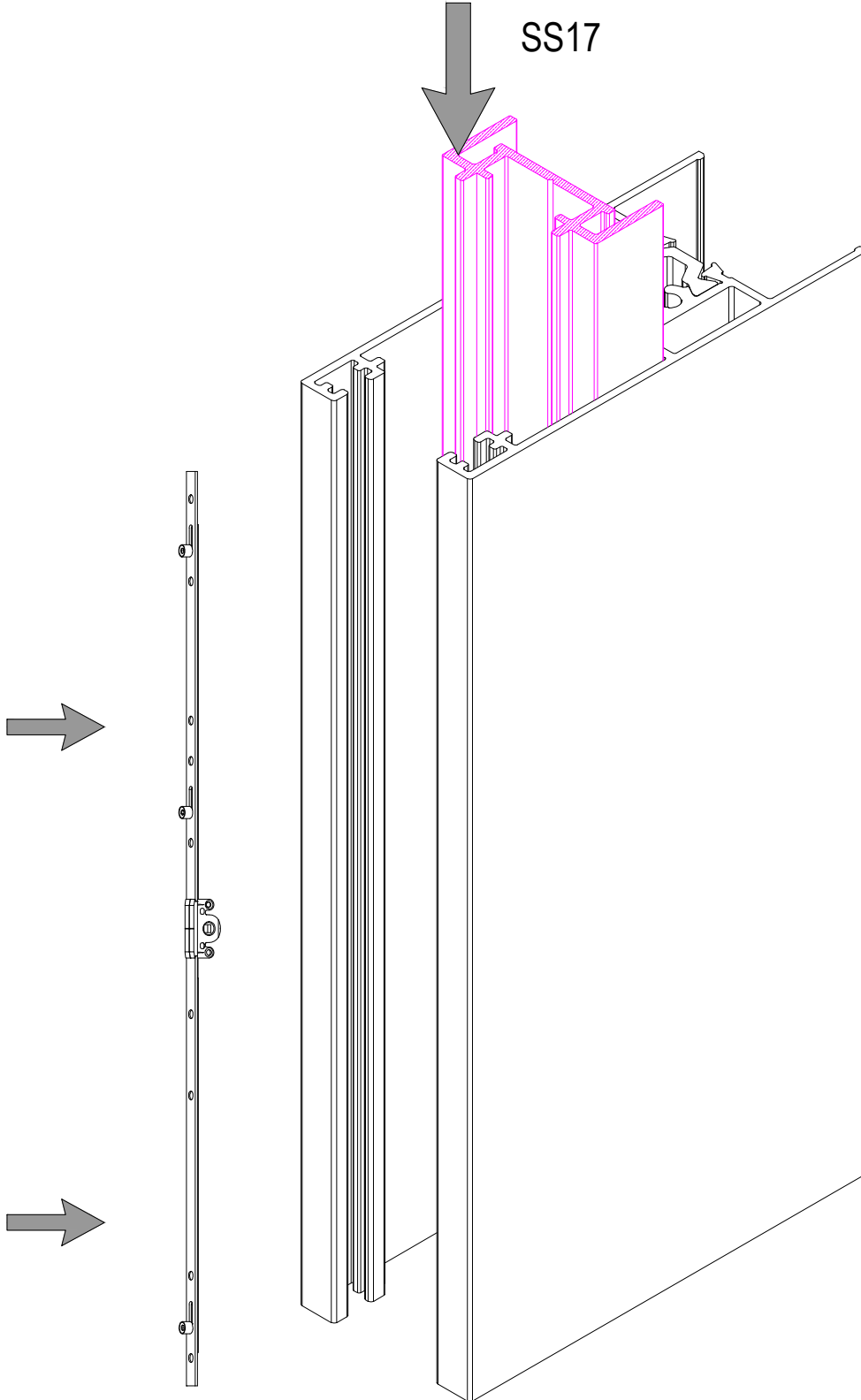

NOT: Profil ağırlıkları teoriktir, üretim sonrası ağırlıklar geçerlidir.

KENET MONTAJ ŞEMASI - LOCKING ASSEMBLY SCHEME

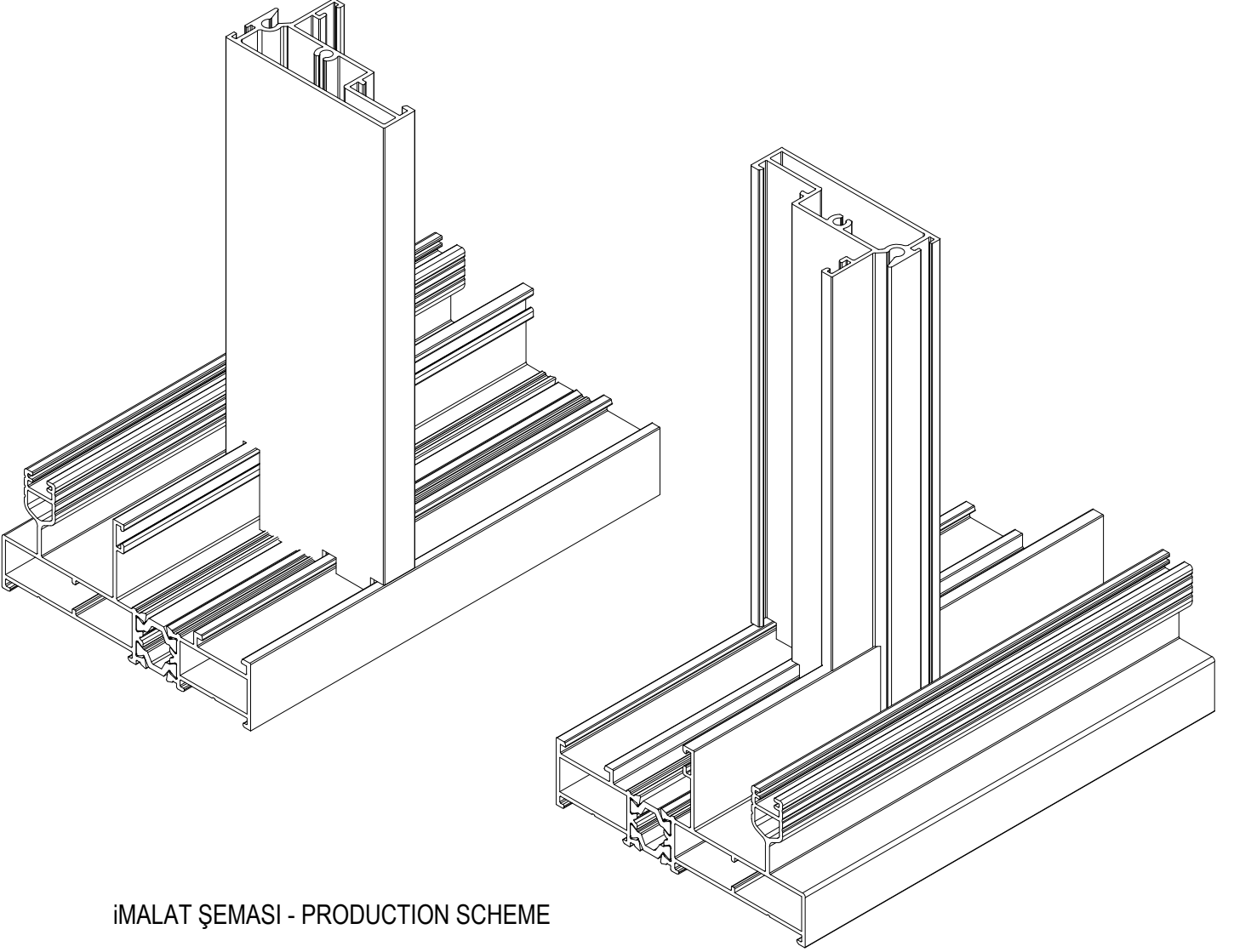

İMALAT ŞEMASI - PRODUCTION SCHEME

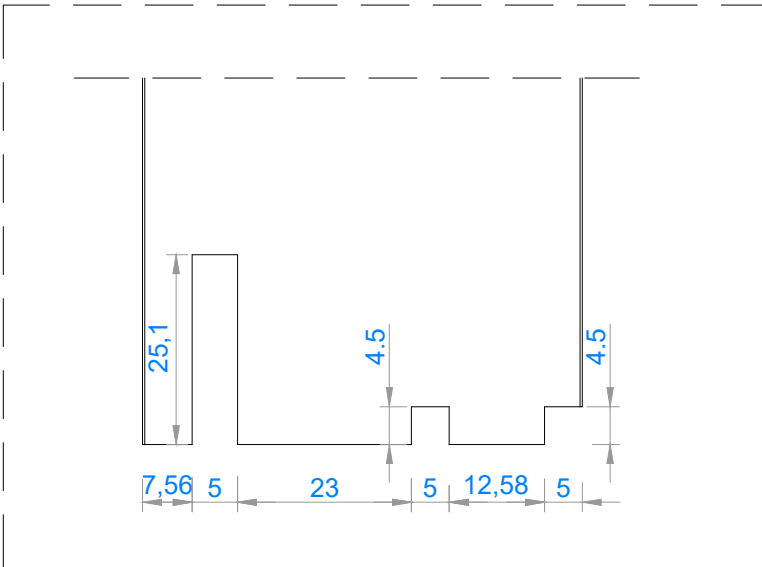

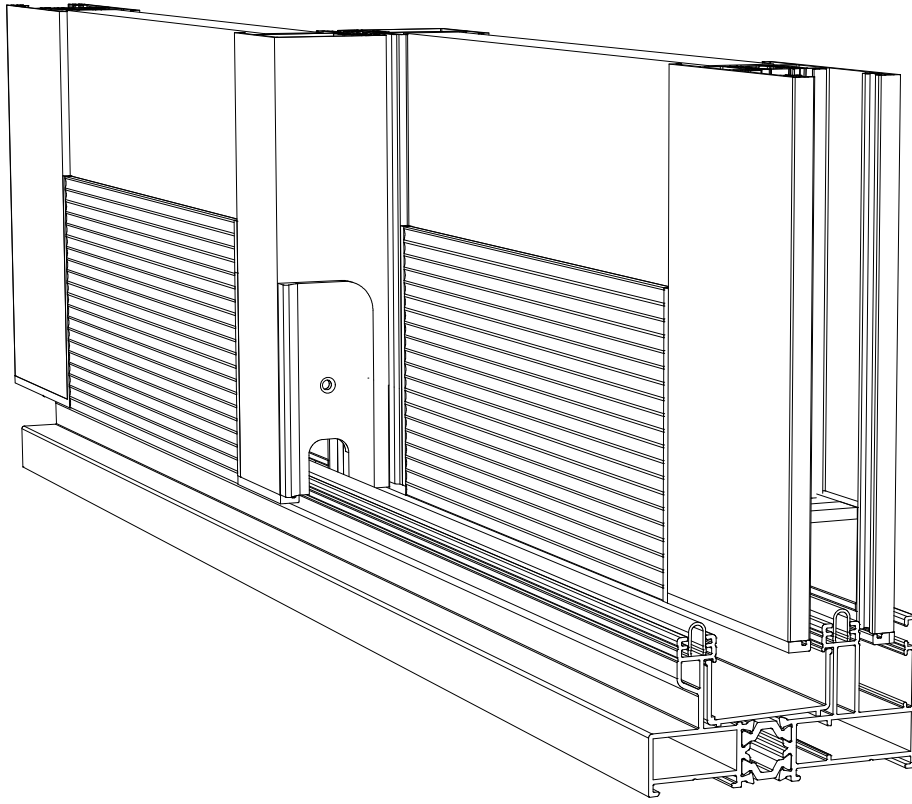







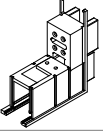
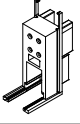
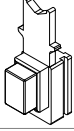

MİMARİ SİSTEMLER

32ST AKSESUARLAR

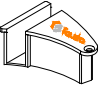
32ST ACCESSORIES

AKSESUAR RESMİ	AKSESUAR KODU	MALZEME	MALZEME TANIMI	AMBALAJ	BİRİM FİYAT
	C01	EPDM	4'LÜ SÜRME ADAPTÖR CONTASI	10 KG/160 MT	
	C02	EPDM	KANAL KAPAMA CONTASI	10 KG/250 MT	
	C03	EPDM	KASA KAPAMA CONTASI	12 KG/160 MT	
	C05	EPDM	İÇ-DİŞ CAM CONTASI	12 KG/265 MT	
	SS-AKS-01	INOX	ÇELİK RAY	1 BOY/6 MT	
	SS-AKS-02	EPDM	SIZDIRMAZLIK PARÇASI	40 AD/ 1 PKT	
	SS-AKS-04	INOX	RULMAN	140 AD/ 1 KOLİ	
	SS-AKS-09	INOX	RULMAN-SİNEKLİK	200 AD/ 1 KOLİ	
	SS-AKS-07	INOX	KİLİT-KARŞILIK	100 TKM/ 1 KOLİ	
	SS-AKS-05	SB	EKSENEL KOL	32 ADET/KOLİ	
		RENKLİ		32 ADET/KOLİ	
		ELOKSAL		32 ADET/KOLİ	
	SS-AKS-08	SB	HAVUZ KOL	32 ADET/KOLİ	
		RENKLİ		32 ADET/KOLİ	
		ELOKSAL		32 ADET/KOLİ	
	LC-1125	INOX	ALYAN KÖŞE	250 AD/ 1 KOLİ	
	KİL FİTİL	NAYLON	$\frac{67}{500}$ $\frac{67}{700}$ KİL FİTİL	4X300MT/KG	

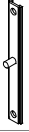
NOT: Profil ağırlıkları teoriktir, üretim sonrası ağırlıklar geçerlidir.

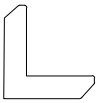
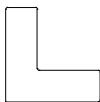
AKSESUAR RESMİ	AKSESUAR KODU	MALZEME	MALZEME TANIMI	AMBALAJ	BİRİM FİYAT
	SS-AKS-10	PVC	90° KANAT KÖŞE TAKOZU	150 AD/ 1 KOLİ	
	SS-AKS-11	PVC	90° KENET KÖŞE TAKOZU	300 AD/ 1 KOLİ	
	SS-AKS-13	PVC	STOPER	500 AD/ 1 KOLİ	
	SS-AKS-03	PVC	DÜZ KENET KAPAK	500 TKM/ 1 KOLİ	
	SS-AKS-14	PVC	TAKVİYELİ KENET KAPAK	500 TKM/ 1 KOLİ	
	B4435	PVC	KASA U PLASTİĞİ	1 BOY/6 MT	
	N0436	PVC	KENET KİTLEME PLASTİĞİ (90°)	1 BOY/6 MT	
	B8802	PVC	KENET KİTLEME PLASTİĞİ (45°)	1 BOY/6 MT	
	SS-AKS-06P	PVC	PENCERE TİJ (75 CM)	ADET	
	SS-AKS-06K	PVC	KAPI TİJ (150 CM)	ADET	
	7 MM X 1 MM	INOX	KÖŞE GÖNYESİ	ADET	
	15 MM X 1,2 MM	INOX	KÖŞE GÖNYESİ	ADET	
	28 MM X 1,5 MM	INOX	KÖŞE GÖNYESİ	ADET	

NOT: Profil ağırlıkları teoriktir, üretim sonrası ağırlıklar geçerlidir.